

**Automotive Test Scope ATS610004DW-XMSG
Automotive Test Scope ATS605004DW-XMS**

User manual

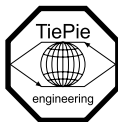

**USB
Network
WiFi
Battery power**



TiePie engineering

ATTENTION!

Measuring directly on the **line voltage** can be very dangerous.

Copyright ©2025 TiePie engineering.
All rights reserved.

Revision 2.52, March 2025

This information is subject to change without notice.
Despite the care taken for the compilation of this user manual,
TiePie engineering can not be held responsible for any damage
resulting from errors that may appear in this manual.

Contents

1	Welcome	1
2	Safety	3
3	Declaration of conformity	5
4	Introduction	9
4.1	Differential input	11
4.1.1	SafeGround on each channel	13
4.1.2	Differential attenuators	14
4.1.3	Differential test lead	15
4.2	Sampling	16
4.3	Sampling rate	16
4.3.1	Aliasing	17
4.4	Digitizing	18
4.5	Signal coupling	19
4.6	Probe compensation	19
5	Driver installation	21
5.1	Introduction	21
5.1.1	Where to find the driver setup	21
5.1.2	Executing the installation utility	21
6	Hardware installation	25
6.1	Power the instrument	25
6.1.1	Charging the battery	26
6.1.2	Long term storage	26
6.2	Instrument operation mode	27
6.3	Connect via LAN	28
6.4	Connect via WiFi	29
6.4.1	The computer/laptop has WiFi	29
6.4.2	The computer/laptop has NO WiFi	30
6.5	Connect via USB	32

6.5.1	Plug into a different USB port	32
6.6	Operating conditions	32
7	Instrument ground compensation	33
7.1	Ground compensation cable	33
7.2	When using the the ground compensation cable	33
7.3	When is the ground compensation not required	34
7.4	Why ground compensation?	34
8	Combining and synchronizing instruments	35
8.1	Limitation	36
9	Front panel	37
9.1	Channel input connectors	37
9.2	EMI probe grounding	37
9.3	Power/Mode button	37
9.4	Status indicators	37
9.4.1	Status	38
9.4.2	LAN	38
9.4.3	WiFi	38
9.4.4	USB	38
9.4.5	Batt	38
10	Rear panel	39
10.1	Power	39
10.1.1	Power adapter	39
10.2	USB	40
10.3	LAN	40
10.4	Factory reset	40
10.5	Extension Connector	41
10.6	Ground connector	41
10.7	CMI	42
10.8	Ventilation slots	42
11	Firmware update	43
11.1	Preparation	43

11.2	Switching to firmware update mode	43
11.3	Updating the firmware	44
12	Web interface	45
12.1	Enter the web interface	45
12.2	Setting a fixed IP address	46
13	Specifications	47
13.1	Definition of accuracy	47
13.2	Acquisition system	47
13.3	Trigger system	49
13.4	Probe calibration	49
13.5	Power	50
13.6	Physical	50
13.7	Multi-instrument synchronization	50
13.8	I/O connectors	51
13.9	Interface	51
13.10	System requirements	51
13.11	Environmental conditions	51
13.12	Certifications and Compliances	51
13.13	Measure leads	52
13.14	Differential attenuators	52
13.15	Package contents	53
13.16	Warranty	53



Wireless measuring has now become a reality with the ATS WiFiScope. If a large distance needs to be bridged between the measuring instrument and the PC, the ATS WiFiScope is the solution for this. Fast measurements and high speed data acquisition are now possible wherever the ATS WiFiScope is located in the world.

- Because the ATS WiFiScope is battery-powered, it can be used stand-alone for a long time.
- For measurements in hazardous situations or places where it is not accessible to people for long, the ATS WiFiScope offers the solution.
- A connection via WiFi or Network (LAN or WAN with possibly POE) gives the user the possibility to place the measuring instrument where this was previously not possible.
- Collecting and viewing measurement data from different locations on a PC / Laptop is now a possibility because the software supports more WiFiScopes at the same time.
- With the very extensive software package, most measurements can be performed.
- A large library of presets is available so that a novice user can immediately perform advanced measurements with a few mouse clicks.
- The ATS WiFiScope has 4 input channels with a maximum sampling rate of 500 MSa/s or 1 GSa/s and a bandwidth of 250 MHz.
- With a WiFi connection, the ATS WiFiScope is no longer directly connected to the PC or laptop and short circuits are excluded, this eliminates the fear that something will happen to the PC or Laptop.
- A big advantage of the WiFiScopes is that no ground loops can occur. In traditional measurement systems, ground loops give many problems, resulting in unreliable measurement results. With the WiFiScope, because of the absence of ground loops, long distance remote measurements are possible without the results being influenced by ground loops. Also on short distances the absence of ground loops is important for performing reliable measurements. The WiFiScope prevents ground loops from forming so that the measurement speed and resolution are not affected and the measurements remain reliable.
- Integrating the ATS WiFiScope in your own software environment is supported by an API with examples so that the ATS WiFiScope can be widely used
- Thanks to a very good hardware structure and advanced software drivers, the ATS WiFiScope is suitable for high speed data acquisition up to speeds of 5 MSa/s and measurements up to 1 GSa/s with a record length of 256 MSamples of memory per channel with a resolution of 12 to 16 bit.

When working with electricity, no instrument can guarantee complete safety. It is the responsibility of the person who works with the instrument to operate it in a safe way. Maximum security is achieved by selecting the proper instruments and following safe working procedures. Safe working tips are given below:

- Always work according (local) regulations.
- Work on installations with voltages higher than 25 V_{AC} or 60 V_{DC} should only be performed by qualified personnel.
- Avoid working alone.
- Observe all indications on the ATS WiFiScope before connecting any wiring
- Check the probes/test leads for damages. Do **not** use them if they are damaged
- Take care when measuring at voltages higher than 25 V_{AC} or 60 V_{DC}.
- Do not operate the equipment in an explosive atmosphere or in the presence of flammable gases or fumes.
- Do not use the equipment if it does not operate properly. Have the equipment inspected by qualified service personal. If necessary, return the equipment to TiePie engineering for service and repair to ensure that safety features are maintained.

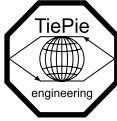

TiePie engineering
Koperslagersstraat 37
8601 WL Sneek
The Netherlands

EC Declaration of conformity

We declare, on our own responsibility, that the product

Automotive Test Scope ATS610004DW-XMSG Automotive Test Scope ATS605004DW-XMS

for which this declaration is valid, is in compliance with

EC directive 2011/65/EU (the RoHS directive)
including up to amendment 2021/1980,

EC regulation 1907/2006 (REACH)
including up to amendment 2021/2045,

and with

EN 55011:2016/A1:2017
EN 55022:2011/C1:2011

IEC 61000-6-1:2019 EN
IEC 61000-6-3:2007/A1:2011/C11:2012 EN

according the conditions of the EMC standard 2004/108/EC,

also with

Canada: ICES-001:2004

Australia/New Zealand: AS/NZS CISPR 11:2011

and

IEC 61010-1:2010/A1:2019

USA: UL 61010-1, Edition 3

and is categorized as $30 V_{RMS}$, $42 V_{pk}$, $60 V_{DC}$

Sneek, 1-9-2022
ir. A.P.W.M. Poelsma

A handwritten signature in blue ink, appearing to read 'A.P.W.M. Poelsma', written over a blue horizontal line.

WiFi module

The ATS WiFiScope contains the PIXI-9377 WiFi module.

FCC reports for this module can be found at [fcc.report/FCC-ID/2AKZA-QCA9377](https://www.fcc.gov/eetd/fccreports/reports/fcc-report/FCC-ID/2AKZA-QCA9377)

FCC statement

FCC 15.119

This device complies with Part 15 of FCC Rules. Operation is Subject to following two conditions:

1. This device may not cause harmful interference, and
2. This device must accept any interference received including interference that cause undesired operation.

FCC 15.105

This equipment has been tested and found to comply within the limits for a Class B digital device, pursuant to part 15 of the FCC Rules. These limits are designed to provide reasonable protection against harmful interference in a residential installation. This equipment generates, uses, and can radiate radio frequency energy and, if not installed and used in accordance with the instructions, may cause harmful interference to radio communications. However, there is no guarantee that interference will not occur in a particular installation. If this equipment does cause harmful interference to radio or television reception, which can be determined by turning the equipment off and on, the user is encouraged to try to correct the interference by one or more of the following measures:

- Reorient or relocate the receiving antenna
- Increase the separation between the equipment and receiver
- Connect the equipment into an outlet on a different circuit from that to which the receiver is connected.
- Consult the dealer or an experienced radio/TV technician for help.

Any changes or modifications not expressly approved by TiePie engineering can void the authority to operate equipment.

This equipment complies with FCC radiation exposure limits set forth for an uncontrolled environment. This equipment should be installed and operated with minimum distance of 20 cm between the radiator and your body

Environmental considerations

This section provides information about the environmental impact of the ATS WiFiScope.

End-of-life handling

Production of the ATS WiFiScope required the extraction and use of natural resources. The equipment may contain substances that could be harmful to the environment or human health if improperly handled at the ATS WiFiScope's end of life.



In order to avoid release of such substances into the environment and to reduce the use of natural resources, recycle the ATS WiFiScope in an appropriate system that will ensure that most of the materials are reused or recycled appropriately.

The shown symbol indicates that the ATS WiFiScope complies with the European Union's requirements according to Directive 2002/96/EC on waste electrical and electronic equipment (WEEE).



Before using the ATS WiFiScope first read chapter 2 about safety.

Many technicians investigate electrical signals. Though the measurement may not be electrical, the physical variable is often converted to an electrical signal, with a special transducer. Common transducers are accelerometers, pressure probes, current clamps and temperature probes. The advantages of converting the physical parameters to electrical signals are large, since many instruments for examining electrical signals are available.

The ATS WiFiScope is a portable four channel measuring instrument with differential inputs. The ATS WiFiScope is available in two versions:

- Automotive Test Scope ATS610004DW-XMSG
- Automotive Test Scope ATS605004DW-XMS

These are almost identical, except for a few differences, which are described later.

The ATS WiFiScope can be connected to the computer via USB, wired ethernet and WiFi. When used via WiFi, the ATS WiFiScope can be connected to an existing WiFi network or can act as access point to create its own WiFi network.

The ATS WiFiScope is equipped with a built-in battery for wireless operation, but can also be powered by an external power supply (included in the package) or via the USB interface.

The native resolutions are 8, 12 and 14 bits and a user selectable resolution of 16 bits is available too, with adjusted maximum sampling rates:

Measuring		ATS610004DW-XMSG	ATS605004DW-XMS
Resolution	Channels		
8 bit	1 ch	1 GSa/s	500 MSa/s
	2 ch	500 MSa/s	200 MSa/s
	3 or 4 ch	200 MSa/s	100 MSa/s
12 bit	1 ch	500 MSa/s	200 MSa/s
	2 ch	200 MSa/s	100 MSa/s
	3 or 4 ch	100 MSa/s	50 MSa/s
14 bit		100 MSa/s	50 MSa/s
16 bit		6.25 MSa/s	3.125 MSa/s

Table 4.1: Maximum sampling rates

The ATS WiFiScope is delivered with 256 MB total memory. Depending on the measurement setup, the amount of memory per channel is:

Measuring		ATS WiFiScope
Resolution	Channels	
8 bit	1 ch	256 MSa
	2 ch	128 MSa
	3 or 4 ch	64 MSa
12, 14, 16 bit	1 ch	128 MSa
	2 ch	64 MSa
	3 or 4 ch	32 MSa

Table 4.2: Maximum record lengths per channel

When used as a (WiFi) network instrument, maximum record lengths are limited.

The ATS WiFiScope supports high speed continuous streaming measurements.

The maximum streaming rates when connected to a USB 3.0 port are:

Measuring		ATS610004DW-XMSG	ATS605004DW-XMS
Resolution	Channels		
8 bit	1 ch	200 MSa/s ¹	100 MSa/s ¹
	2 ch	100 MSa/s ²	50 MSa/s ²
	3 or 4 ch	50 MSa/s ³	25 MSa/s ³
12 bit	1 ch	100 MSa/s ²	50 MSa/s ²
	2 ch	50 MSa/s ³	25 MSa/s ³
	3 or 4 ch	25 MSa/s ⁴	12.5 MSa/s ⁴
14 bit	1 ch	100 MSa/s ²	50 MSa/s ²
	2 ch	50 MSa/s ³	25 MSa/s ³
	3 or 4 ch	25 MSa/s ⁴	12.5 MSa/s ⁴
16 bit		6.25 MSa/s ⁵	3.125 MSa/s

Table 4.3: Maximum streaming rates

¹ ≤ 40 MSa/s when connected to USB 2.0

² ≤ 20 MSa/s when connected to USB 2.0

³ ≤ 10 MSa/s when connected to USB 2.0

⁴ ≤ 5 MSa/s when connected to USB 2.0

⁵ ATS610004DW-XMSG ≤ 3.125 MSa/s when connected to USB 2.0, measuring 3 or 4 channels

These maximum streaming rates are only achieved when using the ATS WiFiScope via its USB interface. When used as wired network instrument, maximum streaming rates may be lower, depending on network speed and load. When used via WiFi, maximum streaming rates will be lower and will depend on WiFi signal strength, distance to access point and network load.

The Automotive Test Scope ATS610004DW-XMSG and Automotive Test Scope ATS605004DW-XMS are equipped with **SureConnect** connection test. **SureConnect** connection test tells you immediately whether your test probe or clip actually makes electrical contact or not. No more doubt whether your probe doesn't make contact or there really is no signal. This is useful when surfaces are oxidized and your probe cannot get a good electrical contact. Simply activate the **SureConnect** and you know whether there is contact or not. Also when back probing connectors in confined places, **SureConnect** immediately shows whether the probes make contact or not.



The Automotive Test Scope ATS610004DW-XMSG and Automotive Test Scope ATS605004DW-XMS also come with resistance measurement on all channels. Resistances up to 2 MOhm can be measured directly. Resistance can be shown in meter displays and can also be plotted versus time in a graph, creating an Ohm scope.



With the **SafeGround** protected ground feature, the differential input of the Automotive Test Scope ATS610004DW-XMSG is switched into a ground current protected single ended input. This allows to perform single ended measurements with e.g. an attenuating oscilloscope probe, without the risk of creating a short circuit to ground. **SafeGround** is only available on the Automotive Test Scope ATS610004DW-XMSG.



With the accompanying software the ATS WiFiScope can be used as an oscilloscope, a spectrum analyzer, a true RMS voltmeter or a transient recorder. All instruments measure by sampling the input signals, digitizing the values, process them, save them and display them.

4.1 Differential input

Most oscilloscopes are equipped with standard, single ended inputs, which are referenced to ground. This means that one side of the input is always connected to ground and the other side to the point of interest in the circuit under test.

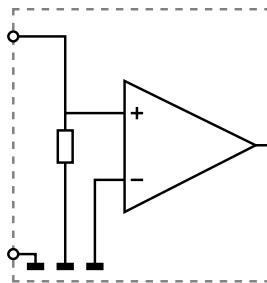

Figure 4.1: Single ended input

Therefore the voltage that is measured with an oscilloscope with standard, single ended inputs is always measured between that specific point and ground.

When the voltage is not referenced to ground, connecting a standard single ended oscilloscope input to the two points would create a short circuit between one of the points and ground, possibly damaging the circuit and the oscilloscope.

A safe way would be to measure the voltage at one of the two points, in reference to ground and at the other point, in reference to ground and then calculate the voltage difference between the two points. On most oscilloscopes this can be done by connecting one of the channels to one point and another channel to the other point and then use the math function CH1 - CH2 in the oscilloscope to display the actual voltage difference.

There are some disadvantages to this method:

- a short circuit to ground can be created when an input is wrongly connected
- to measure one signal, two channels are occupied
- by using two channels, the measurement error is increased, the errors made on each channel will be combined, resulting in a larger total measurement error
- The Common Mode Rejection Ratio (CMRR) of this method is relatively low. If both points have a relative high voltage, but the voltage difference between the two points is small, the voltage difference can only be measured in a high input range, resulting in a low resolution

A much better way is to use an oscilloscope with a differential input.

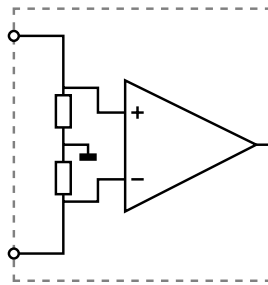

Figure 4.2: Differential input

A differential input is not referenced to ground, but both sides of the input are "floating". It is therefore possible to connect one side of the input to one point in the circuit and the other side of the input to the other point in the circuit and measure the voltage difference directly.

Advantages of a differential input:

- No risk of creating a short circuit to ground
- Only one channel is required to measure the signal
- More accurate measurements, since only one channel introduces a measurement error
- The CMRR of a differential input is high. If both points have a relative high voltage, but the voltage difference between the two points is small, the voltage difference can be measured in a low input range, resulting in a high resolution

Disadvantages of a differential input:

- Higher sensitivity to external disturbances when used with standard measure leads
- Cannot be used in combination with a standard attenuating oscilloscope probe

4.1.1 SafeGround on each channel

The SafeGround protected ground feature of the Automotive Test Scope ATS610004DW-XMSG allows to switch the differential inputs to single ended inputs. This enables to perform single ended measurements as well as using (attenuating) oscilloscope probes. SafeGround can be enabled for each channel individually.

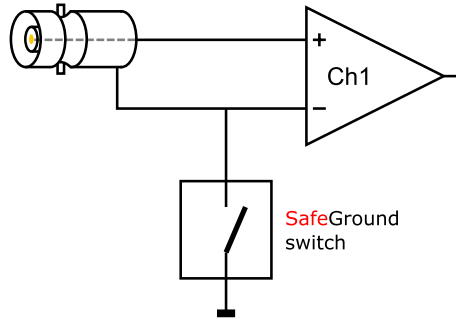



Figure 4.3: SafeGround

A button on each channel toolbar in the software allows to control the SafeGround state between differential  and single ended .

When SafeGround is enabled for a channel, the input is switched to single ended and the ground current of that input is real time monitored. When the ground current becomes too high (<500 mA), the ground connection is immediately (<100 ns) opened, protecting the input against short circuits to ground. Also a warning dialog is shown:

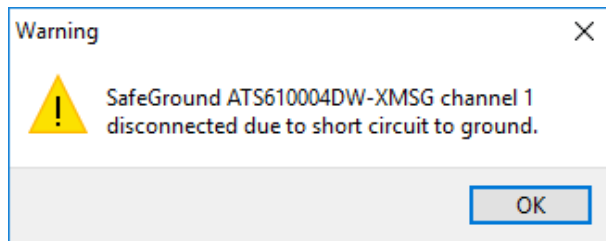

Figure 4.4: SafeGround warning

Once the short circuit is removed, SafeGround can be enabled again.

SafeGround protects your scope, your computer and your circuit under test against accidental wrong ground connections. The SafeGround protected ground feature is default available for the Automotive Test Scope ATS610004DW-XMSG.

4.1.2 Differential attenuators

To increase the input range of the ATS WiFiScope, it comes with a differential 1:10 attenuator for each channel. This differential attenuator is specially designed to be used with the ATS WiFiScope.



Figure 4.5: Differential attenuator

For a differential input, both sides of the input need to be attenuated.

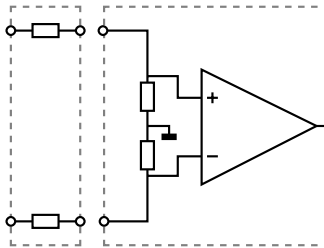

Figure 4.6: Differential attenuator matches with differential input

Standard oscilloscope probes and attenuators only attenuate one side of the signal path. These are not suitable to be used with a differential input. Using these on a differential input will have a negative effect on the CMRR and will introduce measurement errors.

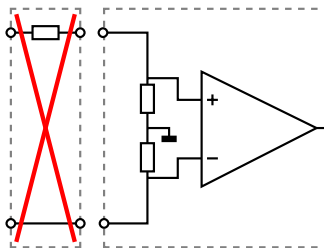

Figure 4.7: Standard probe is mismatch with differential input



The Differential Attenuator and the inputs of the ATS WiFiScope are differential, which means that the outside of the BNCs are not grounded, but carry life signals.

When using the attenuator, the following points have to be taken into consideration:

- do not connect other cables to the attenuator than the ones that are supplied with the instrument
- do not touch the metal parts of the BNCs when the attenuator is connected to the circuit under test, they can carry a dangerous voltage. It will also influence the measurements and create measurement errors.
- do not connect the outside of the two BNCs of the attenuator to each other as this will short circuit a part of the internal circuit and will create measurement errors
- do not connect the outside of the BNCs of two or more attenuators that are connected to different channels of the ATS WiFiScope to each other
- do not apply excessive mechanical force to the attenuator in any direction (e.g. pulling the cable, using the attenuator as handle to carry the ATS WiFiScope, etc.)



When the ATS WiFiScope is equipped with **SafeGround** and the inputs are switched to single ended, using the differential attenuator will lead to significant measurement errors. Use attenuating oscilloscope probes instead.

4.1.3 Differential test lead

Because the outside of the BNC is not connected to ground, using standard shielded coax BNC cables on the differential inputs will introduce measurement errors. The shield of the cable will act as receiving antenna for noise from the surrounding environment, making it visible in the measured signal.

Therefore, the ATS WiFiScope comes with a special differential test lead, one for each channel. This test lead is specially designed to ensure a good CMRR and to be immune for noise from the surrounding environment.

The special differential test lead provided with the ATS WiFiScope is heat resistant and oil resistant.



The differential test lead is only immune for noise when used on a differential input. When the ATS WiFiScope is equipped with **SafeGround** and the inputs are switched to single ended, the differential test lead will **not** be immune for noise. Use standard shielded test leads or oscilloscope probes instead.

4.2 Sampling

When sampling the input signal, samples are taken at fixed intervals. At these intervals, the size of the input signal is converted to a number. The accuracy of this number depends on the resolution of the instrument. The higher the resolution, the smaller the voltage steps in which the input range of the instrument is divided. The acquired numbers can be used for various purposes, e.g. to create a graph.

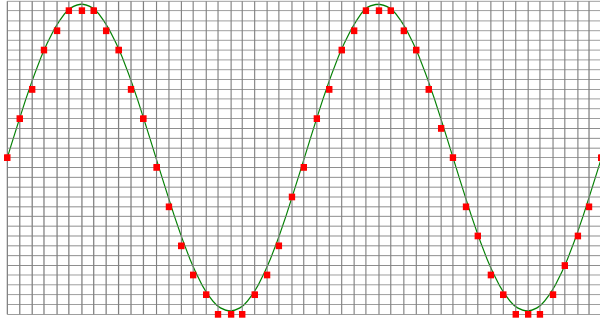

Figure 4.8: Sampling

The sine wave in figure 4.8 is sampled at the dot positions. By connecting the adjacent samples, the original signal can be reconstructed from the samples. You can see the result in figure 4.9.

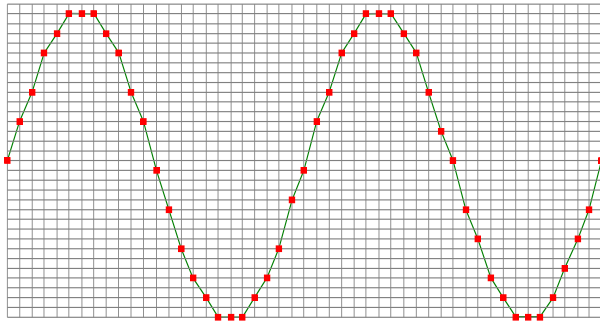

Figure 4.9: "connecting" the samples

4.3 Sampling rate

The rate at which the samples are taken is called the **sampling rate**, the number of samples per second. A higher sampling rate corresponds to a shorter interval between the samples. As is visible in figure 4.10, with a higher sampling rate, the original signal can be reconstructed much better from the measured samples.

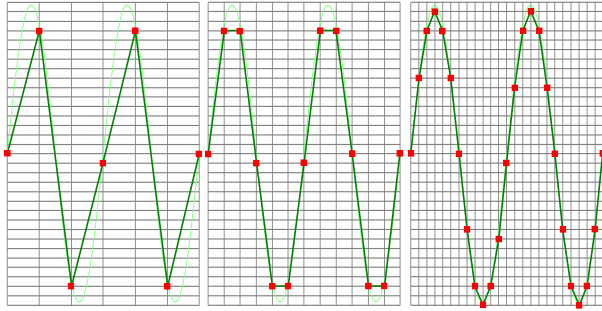

Figure 4.10: The effect of the sampling rate

The sampling rate must be higher than 2 times the highest frequency in the input signal. This is called the **Nyquist frequency**. Theoretically it is possible to reconstruct the input signal with more than 2 samples per period. In practice, 10 to 20 samples per period are recommended to be able to examine the signal thoroughly.

4.3.1 Aliasing

When sampling an analog signal with a certain sampling rate, signals appear in the output with frequencies equal to the sum and difference of the signal frequency and multiples of the sampling rate. For example, when the sampling rate is 1000 Sa/s and the signal frequency is 1250 Hz, the following signal frequencies will be present in the output data:

Multiple of sampling rate	1250 Hz signal	-1250 Hz signal
...		
-1000	$-1000 + 1250 = \mathbf{250}$	$-1000 - 1250 = -2250$
0	$0 + 1250 = 1250$	$0 - 1250 = -1250$
1000	$1000 + 1250 = 2250$	$1000 - 1250 = -250$
2000	$2000 + 1250 = 3250$	$2000 - 1250 = 750$
...		

Table 4.4: Aliasing

As stated before, when sampling a signal, only frequencies lower than half the sampling rate can be reconstructed. In this case the sampling rate is 1000 Sa/s, so we can only observe signals with a frequency ranging from 0 to 500 Hz. This means that from the resulting frequencies in the table, we can only see the 250 Hz signal in the sampled data. This signal is called an **alias** of the original signal.

If the sampling rate is lower than twice the frequency of the input signal, **aliasing** will occur. The following illustration shows what happens.

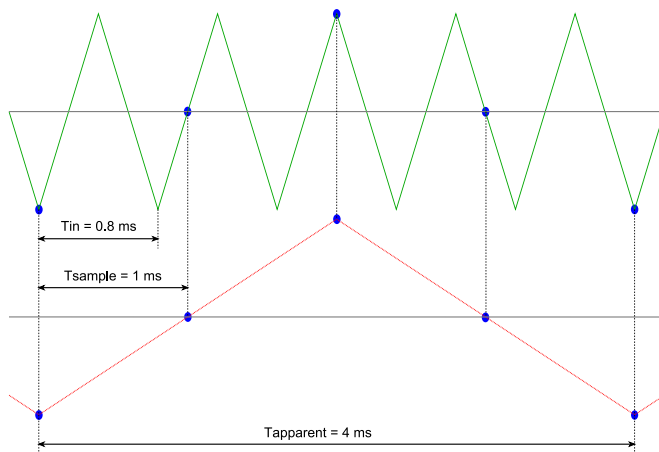

Figure 4.11: Aliasing

In figure 4.11, the green input signal (top) is a triangular signal with a frequency of 1.25 kHz. The signal is sampled with a rate of 1 kSa/s. The corresponding sampling interval is $1/1000\text{Hz} = 1\text{ms}$. The positions at which the signal is sampled are depicted with the blue dots. The red dotted signal (bottom) is the result of the reconstruction. The period time of this triangular signal appears to be 4 ms, which corresponds to an apparent frequency (alias) of 250 Hz ($1.25 \text{ kHz} - 1 \text{ kHz}$).



To avoid aliasing, always start measuring at the highest sampling rate and lower the sampling rate if required.

4.4 Digitizing

When digitizing the samples, the voltage at each sample time is converted to a number. This is done by comparing the voltage with a number of levels. The resulting number is the number corresponding to the level that is closest to the voltage. The number of levels is determined by the resolution, according to the following relation: $LevelCount = 2^{Resolution}$.

The higher the **resolution**, the more levels are available and the more accurate the input signal can be reconstructed. In figure 4.12, the same signal is digitized, using two different amounts of levels: 16 (4-bit) and 64 (6-bit).

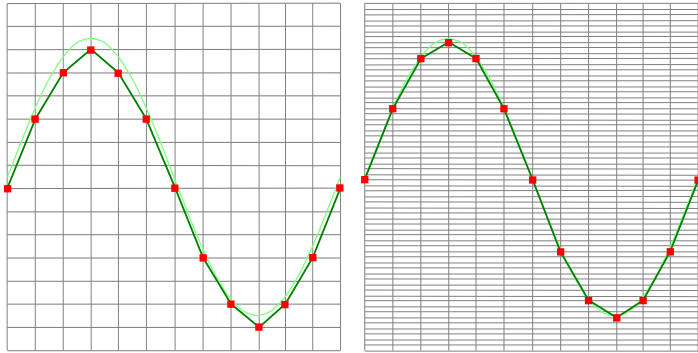

Figure 4.12: The effect of the resolution

The ATS WiFiScope measures at e.g. 14 bit resolution ($2^{14}=16384$ levels). The smallest detectable voltage step depends on the input range. This voltage can be calculated as:

$$\text{VoltageStep} = \text{FullInputRange} / \text{LevelCount}$$

For example, the 200 mV range ranges from -200 mV to +200 mV, therefore the full range is 400 mV. This results in a smallest detectable voltage step of $0.400 \text{ V} / 16384 = 24.41 \mu\text{V}$.

4.5 Signal coupling

The ATS WiFiScope has two different settings for the signal coupling: AC and DC. In the setting DC, the signal is directly coupled to the input circuit. All signal components available in the input signal will arrive at the input circuit and will be measured.

In the setting AC, a capacitor will be placed between the input connector and the input circuit. This capacitor will block all DC components of the input signal and let all AC components pass through. This can be used to remove a large DC component of the input signal, to be able to measure a small AC component at high resolution.



When measuring DC signals, make sure to set the signal coupling of the input to DC.

4.6 Probe compensation

When the inputs of the ATS WiFiScope are switched to single-ended (SafeGround enabled), standard X1 / X10 attenuating oscilloscope probes can be used. These are 1x/10x selectable passive probes. This means that the input signal is passed through directly or 10 times attenuated.



When using an oscilloscope probe in 1:1 the setting, the bandwidth of the probe is only 6 MHz. The full bandwidth of the probe is only obtained in the 1:10 setting

The x10 attenuation is achieved by means of an attenuation network. This attenuation network has to be adjusted to the oscilloscope input circuitry, to guarantee frequency independency. This is called the low frequency compensation. Each time a probe is used on an other channel or an other oscilloscope, the probe must be adjusted.

Therefore the probe is equipped with a setscrew, with which the parallel capacity of the attenuation network can be altered. To adjust the probe, switch the probe to the x10 and attach the probe to a 1 kHz square wave signal. This signal is available at pin 3 of the 9 pin extension connector at the rear of the ATS WiFiScope. Then adjust the probe for a square front corner on the square wave displayed. See also the following illustrations.

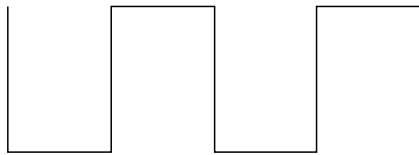

Figure 4.13: correct

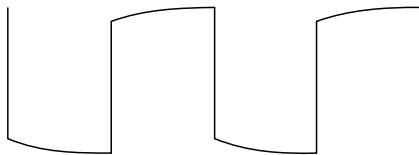

Figure 4.14: under compensated

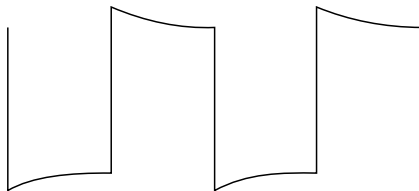

Figure 4.15: over compensated



Before connecting the ATS WiFiScope to the computer via USB, the drivers need to be installed.

5.1 Introduction

To operate a ATS WiFiScope via USB, a driver is required to interface between the measurement software and the instrument. This driver takes care of the low level communication between the computer and the instrument, through USB. When the driver is not installed, or an old, no longer compatible version of the driver is installed, the software will not be able to operate the ATS WiFiScope properly or even detect it at all.

The installation of the USB driver is done in a few steps. Firstly, the driver has to be pre-installed by the driver setup program. This makes sure that all required files are located where Windows can find them. When the instrument is plugged in, Windows will detect new hardware and install the required drivers.

5.1.1 Where to find the driver setup

The driver setup program and measurement software can be found in the download section on TiePie engineering's website. It is recommended to install the latest version of the software and USB driver from the website. This will guarantee the latest features are included.

5.1.2 Executing the installation utility

To start the driver installation, execute the downloaded driver setup program. The driver install utility can be used for a first time installation of a driver on a system and also to update an existing driver.

The screen shots in this description may differ from the ones displayed on your computer, depending on the Windows version.

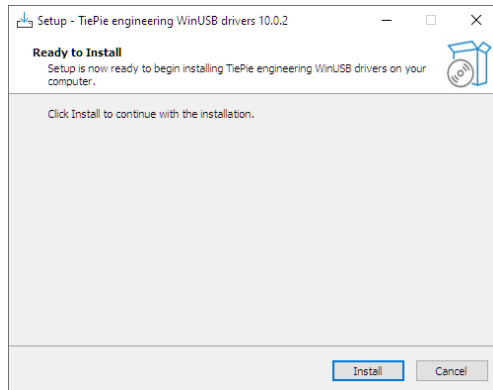

Figure 5.1: Driver install: step 1

When drivers were already installed, the install utility will remove them before installing the new driver. To remove the old driver successfully, **it is essential** that the ATS WiFiScope is disconnected from the computer prior to starting the driver install utility. When the ATS WiFiScope is used with an external power supply, this must be disconnected too.

Clicking **“Install”** will remove existing drivers and install the new driver. A *remove entry* for the new driver is added to the software applet in the Windows control panel.

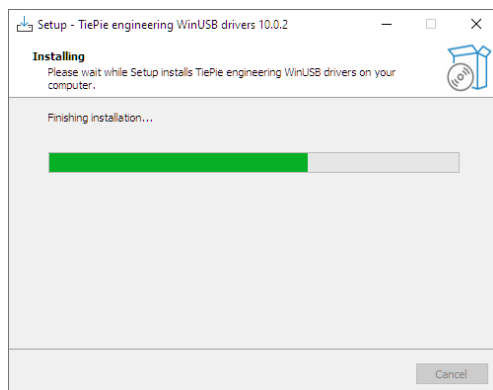

Figure 5.2: Driver install: Copying files



Figure 5.3: Driver install: Finished



Drivers have to be installed before the ATS WiFiScope is connected to the computer via USB for the first time. See chapter 5 for more information.

6.1 Power the instrument

The ATS WiFiScope can be powered in three different ways:

- by its built-in battery
- via an external power adapter, connected to the dedicated power input at the rear panel
- via the USB interface

When using the ATS WiFiScope via its battery, no external power is required. The power consumption of the ATS WiFiScope depends heavily on the settings of the instrument, when using higher sampling rates the instrument uses more power. Also when using larger record lengths, the power consumption increases. It is therefore not possible to give an exact operating time when running on its battery. When the battery is charged, the **Battery** indicator on the front panel will light up green.



When the battery level becomes low, the **Battery** indicator on the front panel will light up red.



It is recommended to recharge the battery. When the **Battery** indicator starts blinking red, the battery is almost empty and immediate recharging is required.

An indicator in the software will show the battery status and an estimation of the remaining operating time.

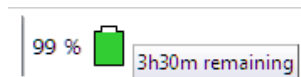

6.1.1 Charging the battery

Charging the battery is done by connecting the external power supply or by connecting the USB. When the battery is charging, the **Battery** indicator on the front panel will light up blue.



When connected to USB or external power, the battery will only be charged when the USB or external power can deliver enough power to operate the instrument and to charge the battery. When not enough power is available, the battery will be discharged. This is indicated by a blue blinking **Battery** indicator on the front panel of the instrument.

6.1.2 Long term storage

When storing the ATS WiFiScope for a long time, it is recommended to first charge the battery to approximately 70 %. Do not store the ATS WiFiScope for a long time with an empty battery or 100 % fully charged battery, as this may reduce battery capacity.

6.2 Instrument operation mode

The ATS WiFiScope has a USB interface and a network interface, used to connect to the instrument via LAN or WiFi. The Power/Mode button at the front panel determines if the ATS WiFiScope operates as USB instrument or as network (LAN or WiFi) instrument. The light in the Power/Mode button indicates in which mode the ATS WiFiScope operates. When it is on, the network interface is enabled and the instrument operates as network (LAN or WiFi) instrument. When it is off, the network interface is disabled and the ATS WiFiScope operates as USB instrument.

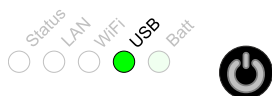

Power/Mode button light off: The ATS WiFiScope can only be used via USB

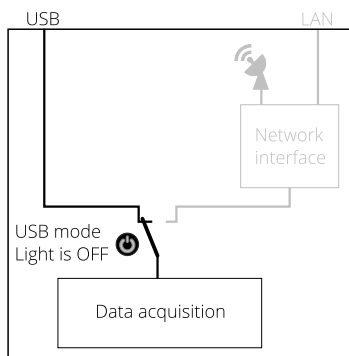

Power/Mode button light on: The ATS WiFiScope can only be used via LAN or WiFi

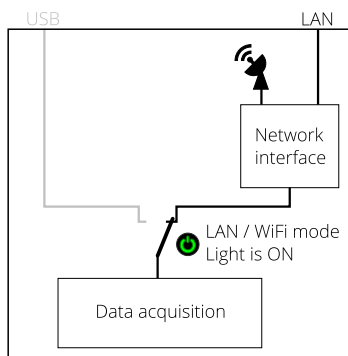

When the network interface of the ATS WiFiScope is disabled, it will go to a low power state, to save the battery. To enable it again, a short press on the Power/Mode button is required.

When the ATS WiFiScope is not connected to external power or USB and is not used for two days (network interface disabled), the ATS WiFiScope switches to "Shipping mode", where the network interface is consuming no power at all. To wake up the ATS WiFiScope from shipping mode, press the Power/Mode button for 2 seconds. When arriving from the factory, the ATS WiFiScope will be in shipping mode.

When for some reason the network interface will not disable (the lights remain on), pressing the Power/Mode button for 3 seconds will force the network interface to be disabled.



For network operation, the ATS WiFiScope uses UDP and TCP/IP **port 5450**. Make sure it is open in your fire wall settings.

6.3 Connect via LAN

To use the ATS WiFiScope via the LAN, connect the ATS WiFiScope LAN port on the rear panel to the LAN via a network cable.



The ATS WiFiScope network interface must be enabled via the Power/Mode button on the front panel of the instrument. While the network interface is initializing, the Power/Mode button will blink, when the initialization is finished, the Power/Mode button will light up continuously.



When the LAN cable is connected, the LAN interface will attempt to get an address via DHCP. When that is successful, the **LAN** indicator on the front panel of the instrument will light up green.

When after 20 seconds no DHCP is found, the network interface will switch to link-local mode and use a link-local address. The **LAN** indicator on the front panel of the instrument will light up blue to indicate link-local mode. Link-local mode remains active until the LAN cable is removed and the LAN LED goes off. When the LAN cable is then reconnected, getting an address via DHCP is attempted again.

In the Multi Channel software, open the Manage instruments dialog and check **Search instruments in local network**.

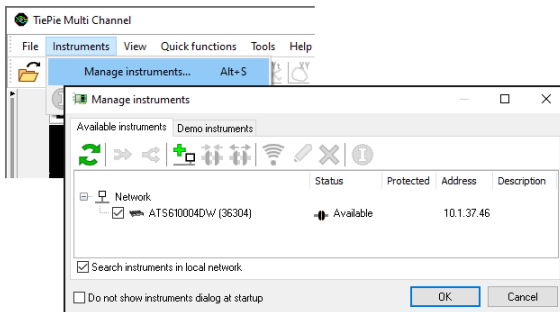

When searching the network is checked, the ATS WiFiScope will appear. To connect the software to the ATS WiFiScope check it and close the dialog with the **OK** button.

6.4 Connect via WiFi

There are several different ways to connect the computer to the ATS WiFiScope via WiFi, depending on whether the computer/laptop has WiFi or not.

6.4.1 The computer/laptop has WiFi

To use the ATS WiFiScope via WiFi, the network interface must be enabled via the Power/Mode button on the front panel of the instrument. While the network interface is initializing, the Power/Mode button will blink, when the initialization is finished, the Power/Mode button will light continuously.



When the computer does have WiFi, there are two different ways to connect to the instrument via WiFi.

Connect the ATS WiFiScope to the local WiFi network

1. In the Multi Channel software open the Manage instruments dialog and check **Search instruments in local network**.
2. Place a check in front of the detected ATS WiFiScope. It may take a few seconds to discover the instrument.
3. The software will now ask how to connect to the ATS WiFiScope, select **Add WiFiScope to the 'WiFi' network**.
4. The connection is now set up, if required, the software will ask for the network password. The setup may take up to 30 seconds.

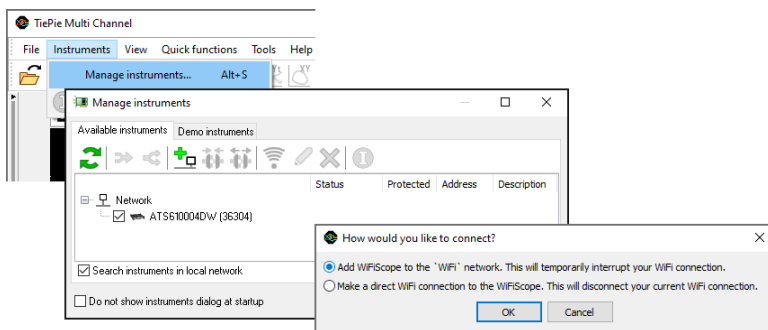

The ATS WiFiScope is now connected to the local network via WiFi.

Connect to the ATS WiFiScope directly using WiFi

1. In the Multi Channel software open the Manage instruments dialog and check **Search instruments in local network**.
2. Place a check in front of the detected ATS WiFiScope. It may take a few seconds to discover the instrument.
3. If the computer is currently connected to a WiFi network, the software will ask how to connect to the ATS WiFiScope, select **Make a direct WiFi connection to the WiFiScope..**
4. The connection is now set up. The setup may take up to 30 seconds.

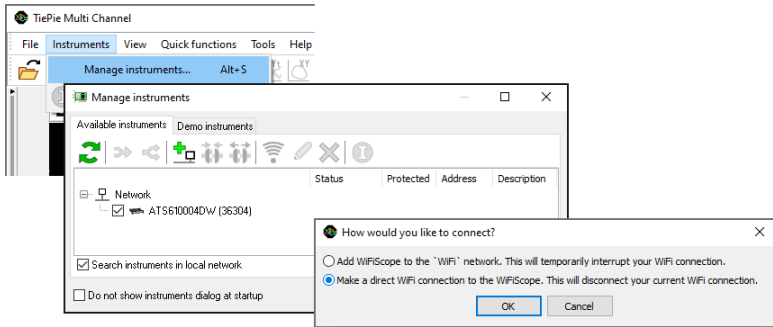

The ATS WiFiScope is now setup as Access Point, to create its own WiFi network. The computer is disconnected from the local WiFi network and connected to the ATS WiFiScope WiFi network. The computer will now no longer have internet access and/or access to network locations.

6.4.2 The computer/laptop has NO WiFi

When the computer has no WiFi, the ATS WiFiScope will have to be connected to the local network. Therefore, the network interface of the ATS WiFiScope must be enabled via the Power/Mode button on the front panel of the instrument. While the network interface is initializing, the Power/Mode button will blink, when the initialization is finished, the Power/Mode button will light continuously.



1. Connect the ATS WiFiScope via a cable to the LAN as shown in the section **Connect via LAN**.
2. In the Multi Channel software open the Manage instruments dialog and check **Search instruments in local network**.
3. Place a check in front of the detected ATS WiFiScope. It may take a few seconds to discover the instrument.

4. Click the WiFi button in the instruments manager to open the ATS WiFiScope web interface.
5. Login to the web interface (default password = **tiepie**).
6. In the web interface, connect to the WiFi network using the **connect** button (and enter its password if required)
7. When successfully connected, close the web interface and disconnect the LAN cable.
8. The Multi Channel software will now detect the ATS WiFiScope via WiFi, this may take a few seconds.

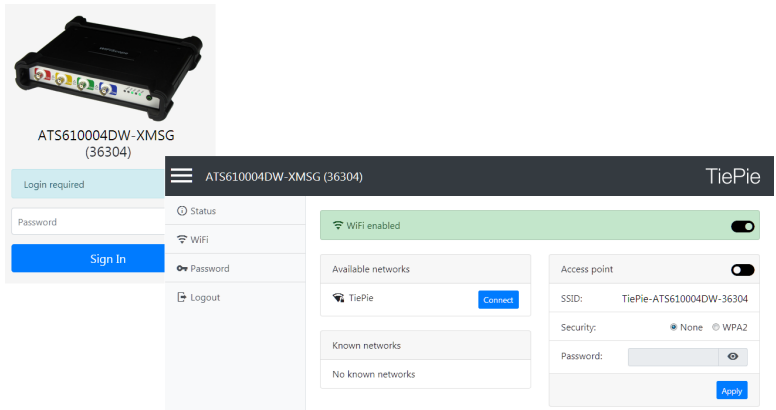
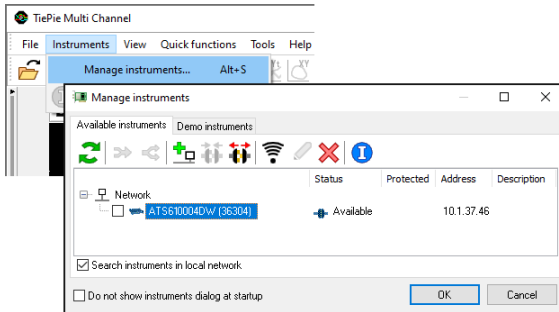

6.5 Connect via USB

To use the ATS WiFiScope via USB, connect the ATS WiFiScope USB port on the rear panel to the computer via a USB cable.



When using the instrument via USB, the network interface must be disabled via the Power/Mode button on the front panel of the instrument.



When a USB connection is established, this is indicated by a green lit **USB** indicator on the front panel of the instrument.

The software can now connect to the ATS WiFiScope as local instrument.

6.5.1 Plug into a different USB port

When the ATS WiFiScope is plugged into a different USB port, some Windows versions will treat the ATS WiFiScope as different hardware and will install the drivers again for that port. This is controlled by Microsoft Windows and is not caused by TiePie engineering.

6.6 Operating conditions

The ATS WiFiScope is ready for use as soon as the software is started. However, to achieve rated accuracy, allow the instrument to settle for 20 minutes. If the instrument has been subjected to extreme temperatures, allow additional time for internal temperatures to stabilize. Because of temperature compensated calibration, the ATS WiFiScope will settle within specified accuracy regardless of the surrounding temperature.

7.1 Ground compensation cable

The ATS WiFiScope is delivered with a special ground compensation cable, together with three corresponding ground clips in different sizes.



Figure 7.1: Ground compensation

The 1.5 m long ground compensation cable has a 2 mm banana plug at one end, that plugs into the small banana socket at the rear of the ATS WiFiScope.



Figure 7.2: Rear ground connection

The other end has a 4 mm banana plug that connects to an alligator clip that can be connected to the ground of the test subject.

7.2 When using the the ground compensation cable

The ground compensation cable between ATS WiFiScope and test subject is required when the ATS WiFiScope is connected to the mains adapter and/or the USB cable, and the test subject is not grounded.

7.3 When is the ground compensation not required

The ground compensation cable between ATS WiFiScope and test subject is not required when:

- When an input is switched to single ended (SafeGround is enabled)
- When the ATS WiFiScope operates on battery power only
- When the input range of the ATS WiFiScope is set to 20 V or higher

7.4 Why ground compensation?

Mains power supplies usually have noise filtering capacitors between the mains input and the output. When a device is powered by such power supply and it is not grounded, the device will float relative to the ground. This floating voltage can get as high as the mains voltage. This is however not dangerous because the current that can flow is very small.

When measuring with a ATS WiFiScope, this floating voltage can affect your measurements because of the high input impedance of the ATS WiFiScope, which is 1 MOhm.

When the ATS WiFiScope is only battery powered, your measurements will not be affected, because the ATS WiFiScope will also float on the floating voltage of the test subject.

When the ATS WiFiScope is connected to the USB or connected to the mains, the floating voltage will cause a high common mode voltage at the input of the ATS WiFiScope. The inputs of the ATS WiFiScope will then clip and you will get strange measurement readings.

The common mode range of the ATS WiFiScope is 2 V (input range 200 mV to 800 mV), 20 V (input range 2 V to 8 V) or 200 V (input range 20V to 80V). So if you measure in the 200mV range and the floating voltage becomes greater than 2 V, the input channel of the ATS WiFiScope will clip and you will measure strange readings. If you measure in the 20 V range (or higher) you will suffer much less from the floating voltage because these are usually smaller than 200 V.

When the ATS WiFiScope ground is connected to the ground of the test subject, they will both get the same ground level, so there will be no (high) common mode voltage due to floating. You will get no measurement errors then.

When more channels are required than one instrument can offer, multiple instruments can be combined into a larger combined instrument. To combine two or more instruments, the instruments need to be connected to each other using special cables.

i

Combining instruments is only available when the ATS WiFiScope is connected to the computer via the USB. When used as network instrument (LAN or WiFi), combining is not possible.

The CMI (Combine Multiple Instruments) interface that is available by default on the ATS WiFiScope provides an easy way to couple multiple oscilloscopes to one combined oscilloscope.

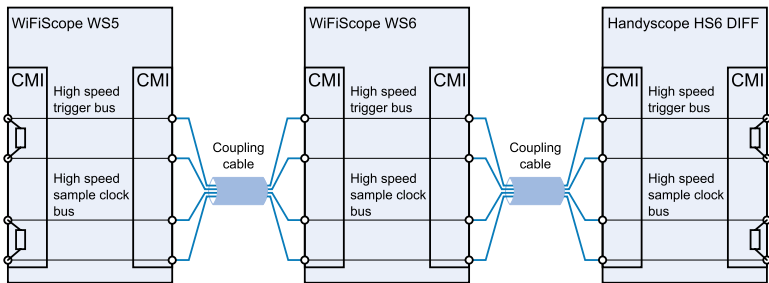

Figure 8.1: CMI diagram

The CMI interface supports automatic recognition of the instrument. The high speed trigger bus is automatically terminated with the correct impedance and the high speed sampling bus is automatically configured and terminated at the beginning and end of the bus. The high speed sampling bus takes care that each Handyscope is fully synchronized to ensure that even at the highest sampling rate the instruments operate at the same sample clock (0 ppm clock error!). The connection order when combining multiple instruments is not important. The CMI interface has built-in intelligence to detect the connections and terminate all buses properly at both ends of the bus. So instruments can be connected to each other in random order. Placing terminators and determining the proper connection order is not required!

Advantages of the CMI (Combine Multiple Instruments) interface are:

- automatic instrument recognition,
- automatic creation and termination of the high speed trigger bus,
- automatic creation and termination of the high speed sampling bus,
- automatic master/slave setting of the sampling clock bus.

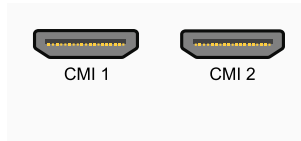

Figure 8.2: CMI connectors

Connecting is done by daisy chaining the CMI connectors of the instruments prior to starting the software, using special coupling cables (order number TP-C50H). The software will detect how the instruments are connected to each other and will automatically terminate the connection bus. The software will combine the connected instruments to one large instrument. The combined instruments will sample using the same clock, with a deviation of 0 ppm.



Figure 8.3: Multiple ATS WiFiScopes combined

A 20 channel instrument is easily made by connecting five ATS WiFiScopes to each other.

8.1 Limitation

Our 2 channel CMI instruments are:

Handscope HS5	WiFiScope WS5
---------------	---------------

Our 4 channel CMI instruments are:

Handscope HS6	Automotive Test Scope ATS610004D-XMSG
Handscope HS6 DIFF	Automotive Test Scope ATS605004D-XMS
WiFiScope WS6	Automotive Test Scope ATS610004DW-XMSG
WiFiScope WS6 DIFF	Automotive Test Scope ATS605004DW-XMS

When combining one or more 2 channel instruments with 4 channel instruments, the daisy chained CMI bus must begin or end with a 4 channel instrument. Additionally, the maximum sampling rate is limited to 100 MSa/s at 14 bit resolution.

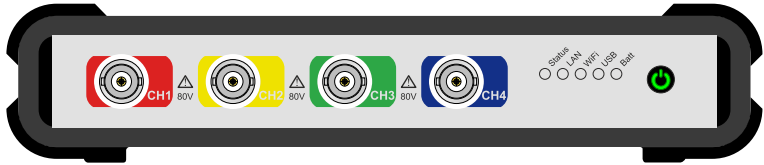

Figure 9.1: Front panel

9.1 Channel input connectors



The CH1 – CH4 Isolated BNC connectors are the main inputs of the acquisition system. The isolated BNC connectors are not connected to the ground of the ATS WiFiScope.

9.2 EMI probe grounding

A ATS WiFiScope with the EMI option installed has a 2 mm banana socket next to the Ch1 input. It is used to ground the EMI probe.

9.3 Power/Mode button

The **Power/Mode** button is situated at the right of the front of the instrument. It is used to switch the mode of the ATS WiFiScope between USB use and LAN / WiFi use. To use the ATS WiFiScope via LAN or WiFi, the network interface must be enabled, by pressing the Power/Mode button. When using the ATS WiFiScope via USB, the network interface must be disabled, by pressing the Power/Mode button again. The Power/Mode button can have the following states:

-  When off, the network module is disabled, the instrument can be connected via USB.
-  When blinking, the network module is initializing.
-  When lit continuously green, the network module is ready, the instrument can be connected via LAN or WiFi.

9.4 Status indicators

The ATS WiFiScope has a number of status indicators, which can be lit to indicate the status of the instrument.

9.4.1 Status

The status light indicates if the instrument is being used by software or not.

- When lit continuously green, the instrument is not being used, it is available to be opened in software.
- When lit continuously blue, the instrument is in use, it is already opened in software.

9.4.2 LAN

When the **LAN** indicator is lit, the instrument is connected to a wired network.

- When lit continuously green, the instrument has received a network address via DHCP.
- When lit continuously blue, the instrument is assigned a link local address.

9.4.3 WiFi

When the **WiFi** indicator is lit, the instrument is connected to the computer and measuring via a WiFi network. The color indicates how the instrument operates:

- When blinking green, the instrument is trying to establish a WiFi connection to an existing network.
- When lit continuously green, the instrument has established a connection to an existing WiFi network and has received a network address via DHCP.
- When lit continuously blue, the instrument acts as WiFi access point. Connect the computer via WiFi to the network that the instrument creates.
- When lit continuously red, WiFi is disabled in the instrument's web interface.

9.4.4 USB

When the **USB** indicator is lit, the instrument is connected to the computer via USB.

- When lit continuously green, the instrument is in operational state.
- When lit continuously blue, the instrument is in firmware update mode.

9.4.5 Batt

The **Batt** indicator can indicate various different states:

- When lit continuously green and the external power is connected, the battery is full. When external power is not connected, the battery is being discharged, its level is higher than 5 %.
- When lit continuously blue, the battery is charging.
- When blinking blue, external power or USB power is connected, but cannot deliver enough power to charge the battery.
- When lit continuously red, the battery level is below 5 %, charging is recommended.
- When blinking red, the battery level is below 2 %, immediate charging is required.
- When fast cycling all colors, the battery is not found or is defective. Contact support@tiepie.nl.

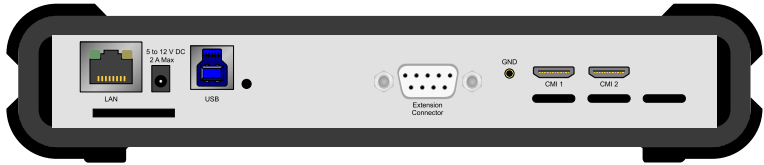

Figure 10.1: Rear panel

10.1 Power

The ATS WiFiScope can be powered by its internal battery, via a dedicated power input at the rear panel and via the USB interface.

To charge the battery, connect the external power supply. The battery can also be charged via the USB, but only if the USB can deliver enough power to operate the instrument and charge the battery. If not enough power for both is available, the battery will not be charged, but will be used by the instrument and be discharged. The Batt status light at the front panel will then blink blue.

The specifications of the dedicated power connector are:



Pin	Dimension	Description
Center pin	Ø1.3 mm	positive
Outside bushing	Ø3.5 mm	ground

Figure 10.2: Power connector

The following minimum and maximum voltages apply to the power inputs:

- **Minimum:** 5 V_{DC} / 2 A
- **Maximum:** 12 V_{DC} / 2 A

10.1.1 Power adapter

The ATS WiFiScope comes with an external 12 V_{DC}2 A power adapter that can be connected to any mains power net that supplies 100 – 240 V_{AC}, 50 – 60 Hz. The external power adapter can be connected to the dedicated power connector.



Figure 10.3: Power adapter

10.2 USB

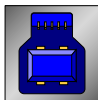

USB

Figure 10.4: USB connector

The ATS WiFiScope is equipped with a USB 3.0 Super speed (5 Gbit/s) interface with a USB 3 type B Super speed socket. It will also work on a computer with a USB 2.0 interface, but will then operate at 480 Mbit/s.

10.3 LAN

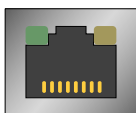

LAN

Figure 10.5: LAN connector

The ATS WiFiScope is equipped with a 1 Gbit LAN interface with RJ45 socket.

10.4 Factory reset

Right next to the LAN connector a reset button is located to perform a factory reset on the ATS WiFiScope. The factory reset clears all user settings like wifi networks and login codes. To perform a factory reset, perform the following steps:

- If the Power/Mode button on the front is lit, press it to switch it off.
- Press the reset button on the rear and keep it pressed.
- While keeping the reset button pressed, press the Power/Mode button on the front again, its light will start blinking.
- Keep the reset button pressed until the Power/Mode button starts to light continuously, then release the reset button. This may take up to 20 seconds.

The instrument is now back in factory state as when it left the factory. It is ready to be used again in the same way as indicated in chapter 6.2.

10.5 Extension Connector



Figure 10.6: Extension connector

A 9 pin female D-sub connector is available at the back of the ATS WiFiScope containing the following signals:

Pin	Description	Pin	Description	Pin	Description
1	EXT 1 (LVTTTL)	4	reserved	7	NC
2	EXT 2 (LVTTTL)	5	reserved	8	Power OUT (see description)
3	Probe Cal	6	GND	9	reserved

Table 10.1: Pin description Extension connector

Pins EXT 1 and EXT 2 are equipped with internal 1 kOhm pull-up resistors to 2.5 V. These pins can simultaneously be used as inputs and outputs. Each pin can be configured as external digital trigger input for the acquisition system of the ATS WiFiScope.

Pin 3, Probe Cal, has a 1 kHz, -1 V to 1 V square wave signal that can be used to perform probe frequency compensations.

Pin 8, Power OUT, is 5 V_{DC} and can supply 100 mA and is available when the Power/Mode button of the ATS WiFiScope is switched on.

10.6 Ground connector

The ATS WiFiScope has a special 2 mm banana ground connector, to connect a ground compensation lead.



Figure 10.7: Ground connector

For a description on how to use the Ground connector and ground compensation lead, see chapter 7.

10.7 CMI

The ATS WiFiScope has two Combine Multiple Instruments interface (CMI) connectors at the rear of the instrument. These connectors are used to combine multiple instruments to a single combined instrument to perform synchronized measurements. This requires a TP-C50H coupling cable per two instruments.

They can also be used to get an external sampling clock OUT.



Figure 10.8: CMI connector

Pin	Description
1	GND
2	EXT CLK OUT P (LVDS)
3	EXT CLK OUT N (LVDS)

Table 10.2: Pin description CMI connector



The CMI connectors use HDMI type C sockets, but are not HDMI compliant. They can not be used to connect an HDMI device to the ATS WiFiScope.

10.8 Ventilation slots

Below the LAN connector and power connector a ventilation slot is located, with a fan behind it. And below the CMI connectors three smaller ventilation slots are located.

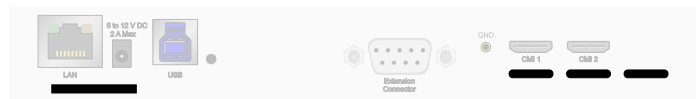

Figure 10.9: Ventilation slots



Do not block the ventilation slots as this may cause the ATS WiFiScope becoming too hot.
Do not insert objects in the ventilation slot as this may damage the fan.

The network module of the ATS WiFiScope has internal firmware, that determines its capabilities, when the ATS WiFiScope is connected via LAN or WiFi. This firmware can be updated to add new functionality. This chapter describes the steps to update the firmware of the ATS WiFiScope.

11.1 Preparation



Updating the firmware will clear all entered WiFi network logins.

First make sure that the firmware update image file is obtained and stored on a readily available location on the computer.

To update the firmware, a USB connection between the computer and the ATS WiFiScope is required, make sure that the USB cable for the ATS WiFiScope is available. Plug the USB cable in a free USB port of the computer, but do **not** connect it to the ATS WiFiScope yet.

- Start the latest version of the Multi Channel software, available from the website.
- In the Multi Channel software, open the **Manage instruments** window, via the **Instruments** menu or hotkey **Alt + S**
- Disconnect the ATS WiFiScope from external power and, when used, from the wired LAN.
- Switch the Power/Mode button **off**. All indicators on the front panel of the ATS WiFiScope are now off.



11.2 Switching to firmware update mode

- Press the Power/Mode button and keep it pressed.
- When the battery indicator lights up, plug the USB cable in the instrument. The USB light will now turn blue. The color of the Batt light is not relevant.



- Now release the Power/Mode button. All lights now turn blue. The Batt light is still not relevant. The ATS WiFiScope is now in firmware update mode.



11.3 Updating the firmware

The **Manage instruments** window now has an additional tab **Update firmware**, switch to that tab page.

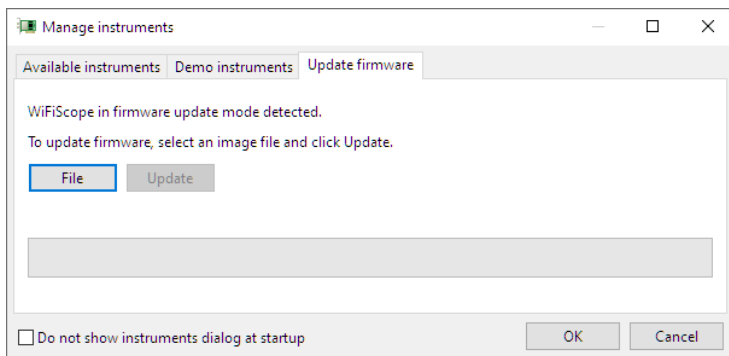

Click the **"File"** button and in the File open dialog, browse to the location of the firmware image file and select the image file. The **"Update"** button is now enabled, click it to start the firmware update process.

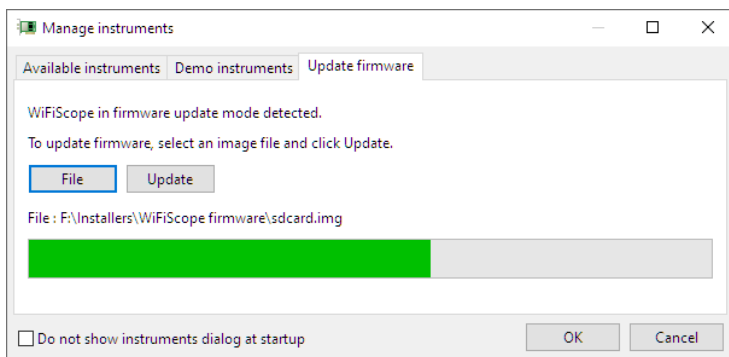

A progress bar will show the status of the update. The update process will take approximately 1 minute. When the update is ready, a notification will be shown.

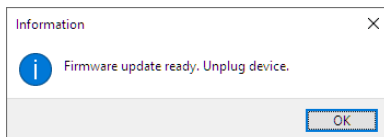

Now unplug the instrument from the USB. The ATS WiFiScope can now be used via LAN and WiFi again.

The ATS WiFiScope has a web interface in which status information of the instrument can be found and in which WiFi network settings can be changed.

12.1 Enter the web interface

1. Connect the ATS WiFiScope via a cable to the LAN.
2. In the Multi Channel software open the Manage instruments dialog and check **Search instruments in local network**.
3. Place a check in front of the detected ATS WiFiScope. It may take a few seconds to discover the instrument.
4. Click the WiFi button in the instruments manager to open the ATS WiFiScope web interface.
5. Login to the web interface (default password = **tiepie**).

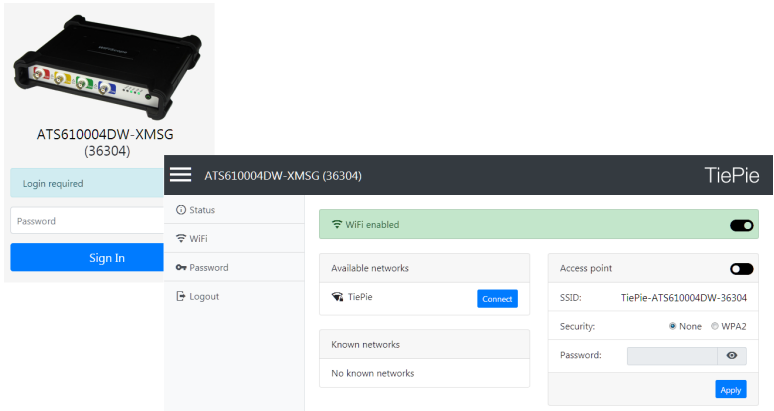
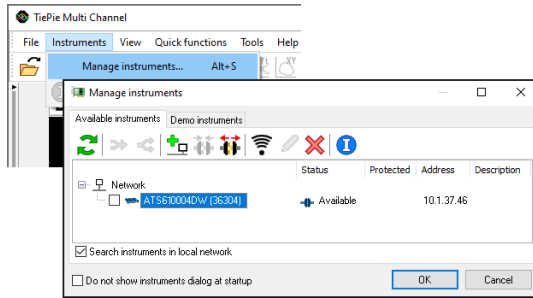

12.2 Setting a fixed IP address

By default, the ATS WiFiScope is setup to receive an IP address by the DHCP server in the local network. When the ATS WiFiScope is connected via wired LAN, it is possible to set a fixed IP address, for the instrument to use.

The settings for a fixed IP address are found on the **Status** page in the web interface.

The screenshot displays the web interface for an ATS610004DW-XMSG (36304) instrument. The interface is titled 'TiePie' and shows the 'Status' page. The left sidebar contains navigation options: Status, WiFi, Password, and Logout. The main content area is divided into three sections:

- Instrument:** Model: ATS610004DW-XMSG (36304), Serial number: 36304, Calibration date: 2019-08-23 (with a 'Request recalibration' button), Firmware version: wifiscope-v2-2023-06-27, Battery: 100%.
- Ethernet:** Connected, IPv4 Address: 10.1.37.64/8 (with an edit button), IPv4 Gateway: 10.0.0.1, Connection speed: 1000 MBit/s, MAC Address: 00:1F:7B:86:AB:3E.
- WiFi:** Access point active as TiePie-ATS610004DW-36304, IPv4 Address: 192.168.255.1/24, Mode: Access point, Access point (SSID): TiePie-ATS610004DW-36304, Access point (BSSID): 00:1F:7B:31:11:FE, Security type: Open, MAC Address: 00:1F:7B:31:11:FE.

Clicking the edit button (pen symbol) behind the IPv4 address opens the IPv4 address edit page.

By default, the **Method** is set to **Automatic (DHCP)**, where the DHCP server in the network assigns an IP address to the ATS WiFiScope.

When the **Method** is set to **Manual**, the following settings can be defined manually, to your preferences:

- IP address
- Subnet mask
- Gateway
- DNS server

When the ATS WiFiScope is connected via WiFi, it is not possible to set a fixed IP address.

To achieve rated accuracy, allow the instrument to settle for 20 minutes. When subjected to extreme temperatures, allow extra time for internal temperatures to stabilize. Because of temperature compensated calibration, the ATS WiFiScope will settle within specified accuracy regardless of the surrounding temperature.

13.1 Definition of accuracy

The accuracy of an input channel is defined as a percentage of the Full Scale range. The Full Scale range runs from *-range* to *range* and is effectively $2 * range$. When the input range is set to 4 V, the Full Scale range is -4 V to 4 V = 8 V. Additionally a number of Least Significant Bits is incorporated. The accuracy is determined in the highest resolution.

When the accuracy is specified as $\pm 0.25\%$ of the Full Scale range ± 1 LSB, and the input range is 4 V, the maximum deviation the measured value can have is $\pm 0.25\%$ of 8 V = ± 20 mV. ± 1 LSB equals $8 \text{ V} / 65536$ (= number of LSB at 16 bit resolution) = $\pm 122 \mu\text{V}$. Therefore the measured value will be between 20.122 mV lower and 20.122 mV higher than the actual value. When e.g. applying a 3.75 V signal and measuring it in the 4 V range, the measured value will be between 3.770122 V and 3.729878 V.

13.2 Acquisition system

Number of input channels	4 analog		
CH1, CH2, CH3, CH4	Isolated BNC, female		
Type	Differential		
Resolution	8, 12, 14, 16 bit user selectable		
Accuracy	0.25% of full scale ± 1 LSB		
Ranges (full scale)	± 200 mV ± 2 V ± 20 V	± 400 mV ± 4 V ± 40 V	± 800 mV ± 8 V ± 80 V
Coupling	AC/DC		
Noise	305 μV_{RMS} (200 mV range, 12 bit, 50 MSa/s) 90 μV_{RMS} (200 mV range, 16 bit, 6.25 MSa/s)		
Impedance			
SafeGround disabled	2 M Ω / 12 pF $\pm 1\%$		
SafeGround enabled	1 M Ω / 20 pF $\pm 1\%$		
Maximum voltage	200 V (DC + AC peak <10 kHz)		
Maximum Common Mode voltage	200 mV to 800 mV ranges : 2 V 2 V to 8 V ranges : 20 V 20 V to 80 V ranges : 200 V		
Common Mode Rejection Ratio	-47 dB		
Bandwidth			
-3 dB, at 75 % of full scale	250 MHz		
Limit, selectable per channel	Off (250 MHz) 150 MHz 100 MHz 50 MHz		
AC coupling cut off freq. (-3dB)	± 1.5 Hz		

Acquisition system (continued)

SureConnect			
Maximum voltage on connection 200 V (DC + AC peak <10 kHz)			
Resistance measurement			
Ranges	1 k Ω 10 k Ω 100 k Ω 1 M Ω	2 k Ω 20 k Ω 200 k Ω 2 M Ω	5 k Ω 50k Ω 500 k Ω
Accuracy	1%		
Response time (to 95%)	<10 μ s		
SafeGround Only available on ATS610004DW-XMSG			
Maximum voltage on connection 200 V (DC + AC peak <10 kHz)			
Maximum switch off current	500 mA		
Response time	<100 ns		
Maximum sampling rate	ATS610004DW-XMSG	ATS605004DW-XMS	
8 bit			
Measuring 1 channel	1 GSa/s	500 MSa/s	
Measuring 2 channels	500 MSa/s	200 MSa/s	
Measuring 3 or 4 channels	200 MSa/s	100 MSa/s	
12 bit			
Measuring 1 channel	500 MSa/s	200 MSa/s	
Measuring 2 channels	200 MSa/s	100 MSa/s	
Measuring 3 or 4 channels	100 MSa/s	50 MSa/s	
14 bit	100 MSa/s	50 MSa/s	
16 bit	6.25 MSa/s	3.125 MSa/s	
Maximum streaming rate ^{6,7}	ATS610004DW-XMSG	ATS605004DW-XMS	
8 bit			
Measuring 1 channel	200 MSa/s ¹	100 MSa/s ¹	
Measuring 2 channels	100 MSa/s ²	50 MSa/s ²	
Measuring 3 or 4 channels	50 MSa/s ³	25 MSa/s ³	
12 bit			
Measuring 1 channel	100 MSa/s ²	50 MSa/s ²	
Measuring 2 channels	50 MSa/s ³	25 MSa/s ³	
Measuring 3 or 4 channels	25 MSa/s ⁴	12.5 MSa/s ⁴	
14 bit			
Measuring 1 channel	100 MSa/s ²	50 MSa/s ²	
Measuring 2 channels	50 MSa/s ³	25 MSa/s ³	
Measuring 3 or 4 channels	25 MSa/s ⁴	12.5 MSa/s ⁴	
16 bit	6.25 MSa/s ⁵	3.125 MSa/s	
¹ \leq 40 MSa/s when connected to USB2 ² \leq 20 MSa/s when connected to USB2 ³ \leq 10 MSa/s when connected to USB2 ⁴ \leq 5 MSa/s when connected to USB2 ⁵ ATS610004DW-XMSG \leq 3.125 MSa/s when connected to USB2, measuring 2 or more channels ⁶ On some computers, the highest streaming rates may not be available, due to computer restrictions. ⁷ When connected through LAN or WiFi, the maximum streaming rates are limited and depend on the speed and load of the network			

Acquisition system (continued)

Sampling source		
Internal	TCXO	
Accuracy	$\pm 0.0001\%$	
Stability	± 1 ppm over 0 °C to +55 °C	
Time base aging	± 1 ppm per year time base aging	
External		
Input frequency	LV-TTL (2.5 V), on Extension connector	
	10 MHz $\pm 1\%$ 16.369 MHz $\pm 1\%$	
Memory		
8 bit	via USB	via LAN/WiFi
Measuring 1 channel	256 MSa	64 MSa
Measuring 2 channels	128 MSa	32 MSa
Measuring 3 or 4 channels	64 MSa	16 MSa
12, 14, 16 bit		
Measuring 1 channel	128 MSa	32 MSa
Measuring 2 channels	64 MSa	16 MSa
Measuring 3 or 4 channels	32 MSa	8 MSa

13.3 Trigger system

Triggering is only available when the ATS WiFiScope operates in block mode, not when operating in streaming mode

System	Digital, 2 levels	
Source	CH1, CH2, CH3, CH4, digital external, OR	
Trigger modes	Rising / Falling / Any edge, Inside / Outside window, (time conditions only on Ch1) Enter / Exit window, (time conditions only on Ch1) Pulse width, (only on Ch1) Interval (only on Ch1)	
Level adjustment	0 to 100% of full scale	
Hysteresis adjustment	0 to 100% of full scale	
Resolution	0.024 % (12 bits)/0.006 % (14/16 bits)	
Pre trigger	0 to selected record length, 1 sample resolution	
Post trigger	0 to selected record length, 1 sample resolution	
Trigger hold-off	0 to 64 MSamples, 1 sample resolution	
Trigger delay	0 to 16 GSamples, 1 sample resolution	
Digital external trigger		
Input	Extension connector pins 1 and 2	
Range	0 to 2.5 V (TTL)	
Coupling	DC	
Jitter	≤ 1 sample	

13.4 Probe calibration

Output	Extension connector pins 3 (signal) and 6 (ground)
Signal	
Level	-1 V to 1 V
Frequency	1 kHz

13.5 Power

Power	From USB, external input or built-in battery
Consumption	12 V _{DC} , 2 A max
Internal battery	Li-ion
Capacity	7000 mAh, 3.7 V
Operating time	Strongly depending on instrument setup, ≥ 3 hours
Power adapter	External
Input	110 to 240 V _{AC} , 50 to 60 Hz, 500 mA
Output	12 V _{DC} , 2 A
Dimension	
Height	57 mm / 2.2"
Width	30 mm / 1.2"
Length	88 mm / 3.4"
Cable length	1.8 m / 70"
Order number	TP-UES24LCP-120200SPA
Replaceable mains plugs for	EU, US, AU, UK

13.6 Physical

Height	44 mm / 1.7"
Length	187 mm / 7.4"
Width	215 mm / 8.5"
Weight	751 g / 26.5 ounce
USB cord length	1.5 m / 59"

13.7 Multi-instrument synchronization

Using CMI	Combining instruments is only available when all instruments are connected via USB. When connected via LAN or WiFi, combining via CMI is not available.	
Maximum number of instruments	Limited by available number of USB ports	
Synchronization accuracy	0 ppm	
CMI interface	2x, CMI 1, CMI 2	
Required coupling cable	TP-C50H Coupling cable CMI	
Maximum coupling cable length	50 cm	
Using WCMI		
Maximum number of instruments	No limitation	
Required coupling module	WCMI-8 and WCMI-9	
Clock synchronization accuracy	≤ 1 ppm, typical ≤ 0.2 ppm	
Trigger jitter at sample rate *	≤ 1 MSa/s	> 1 MSa/s
2 x "5"	≤ ±2 samples	≤ ±2 μs
"5" and "6"		
Trigger source = "5"	≤ ±2 samples	≤ ±2 μs
Trigger source = "6"	≤ ±8 samples	≤ ±8 μs
2 x "6"	≤ ±8 samples	≤ ±8 μs

* "5" = WiFiScope W55 or Handyscope HS5

"6" = WiFiScope W56 (DIFF) or Handyscope HS6 (DIFF)

13.8 I/O connectors

CH1, CH2, CH3, CH4	Isolated BNC, female
USB	USB3 type B Super Speed socket
LAN	RJ45 socket
Extension connector	D-sub 9 pins female
Power	3.5 mm power socket
CMI connectors 1–2	HDMI type C socket

13.9 Interface

USB	USB 3.0 SuperSpeed (5 Gbit/s) (USB 2.0 HighSpeed (480 Mbit/s) compatible)
Network	
LAN	1 Gbps
WiFi	802.11
Network port (TCPIP and UDP)	5450 (IANA assigned)

13.10 System requirements

PC I/O connection	USB 2.0 or newer
Operating System	Windows 10 / 11, 64 bits

13.11 Environmental conditions

	Ambient Temperature	Relative Humidity
Operating with charging		
for rated accuracy	20 °C to 25 °C	10 to 90 % non condensing
without specifications	20 °C to 30 °C	10 to 90 % non condensing
Operating without charging		
for rated accuracy	20 °C to 25 °C	10 to 90 % non condensing
without specifications	10 °C to 40 °C	10 to 90 % non condensing
Charging	0 °C to 35 °C	10 to 90 % non condensing
Storage	0 °C to 35 °C	5 to 95 % non condensing

13.12 Certifications and Compliances

CE mark compliance	Yes
RoHS	Yes
REACH	Yes
EN 55011:2016/A1:2017	Yes
EN 55022:2011/C1:2011	Yes
IEC 61000-6-1:2019 EN	Yes
IEC 61000-6-3:2007/A1:2011/C11:2012	Yes
ICES-001:2004	Yes
AS/NZS CISPR 11:2011	Yes
IEC 61010-1:2010/A1:2019	Yes
UL 61010-1, Edition 3	Yes

13.13 Measure leads

Model	TP-C1812B
Type	Differential
Connectors	
Instrument side	Isolated male BNC connector
Test point side	Red and black 4 mm shrouded banana plugs
Bandwidth	7 MHz
Safety	CAT III, 1000 V, double isolated
Dimensions	
Total length	3000 mm
Length to split	1800 mm
Length individual ends	1200 mm
Weight	80 g
Color	Black
Heat resistant	Yes
Certification and compliances	
CE conformity	Yes
RoHS	Yes
Accessories	
Color coding rings	5 x 3 rings, various colors
Suitable instrument	ATS WiFiScope

13.14 Differential attenuators

Model	TP-DA10
Attenuation	10 x, differential
Bandwidth	25 MHz
Input impedance	10 M Ω // 15 pF
Maximum input voltage	300 V
Input connector	Female BNC
Output connector	Male BNC
Dimensions	
Length	79 mm
Diameter	19 mm
Weight	30 g
Suitable instrument	ATS WiFiScope

13.15 Package contents

Instrument	ATS WiFiScope
Measure leads	4 x Measure lead TP-C1812B, Differential BNC to 4 mm banana plug, 3 m long
Differential attenuator	4 x Differential Attenuator TP-DA10
Alligator clips, large	8 x Alligator Clip TP-AC80: green, blue, yellow, red and 4 x black
Alligator clips, medium	8 x Alligator Clip TP-AC10: green, blue, yellow, red and 4 x black
Alligator clips, small	8 x Alligator Clip TP-AC5: green, blue, yellow, red and 4 x black
Accessories	Ground compensation cable TP-GCC150 with 3 alligator clips External power adapter network cable USB cable
Software	Windows 10 / 11, 64 bits, via website
Drivers	Windows 10 / 11, 64 bits, via website
Software Development Kit	Windows 10 / 11 (64 bits) and Linux, via website
Manual	Quick Start Guide, Instrument manual and software manual

13.16 Warranty

TiePie engineering instruments are designed, manufactured and tested to provide high reliability. In the unlikely event you experience difficulties, the TiePie engineering instruments are fully warranted for two years.

This warranty includes	All parts and labor (excluding probes and/or measure leads and/or batteries) Warranty on batteries is 6 months. No charge for return shipping Long-term 7 year support Upgrade to the latest software at no charge
Optionally available	Extension to five year warranty, option W5

If you have any suggestions and/or remarks regarding this manual, please contact:

TiePie engineering
Koperslagersstraat 37
8601 WL SNEEK
The Netherlands

Tel.: +31 515 415 416
Fax: +31 515 418 819
E-mail: support@tiepie.nl
Site: www.tiepie.com



