

# Automotive Test Scope ATS6

User manual

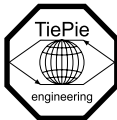

TiePie engineering

ATTENTION!

Measuring directly on the **line voltage** can be very dangerous.

Copyright ©2022 TiePie engineering.  
All rights reserved.

Revision 2.40, July 2022

Despite the care taken for the compilation of this user manual, TiePie engineering can not be held responsible for any damage resulting from errors that may appear in this manual.

# Contents

<b>1</b>	<b>Safety</b>	<b>1</b>
<b>2</b>	<b>Declaration of conformity</b>	<b>3</b>
<b>3</b>	<b>Introduction</b>	<b>5</b>
3.1	Differential input	7
3.1.1	SafeGround on each channel	8
3.1.2	Differential attenuators	9
3.1.3	Differential test lead	11
3.2	Sampling	11
3.3	Sampling rate	12
3.3.1	Aliasing	13
3.4	Digitizing	14
3.5	Signal coupling	15
3.6	Probe compensation	15
<b>4</b>	<b>Driver installation</b>	<b>17</b>
4.1	Introduction	17
4.2	Computers running Windows 10	17
4.3	Computers running Windows 8 or older	17
4.3.1	Where to find the driver setup	17
4.3.2	Executing the installation utility	17
<b>5</b>	<b>Hardware installation</b>	<b>21</b>
5.1	Power the instrument	21
5.1.1	External power	21
5.2	Connect the instrument to the computer	21
5.3	Plug into a different USB port	22
5.4	Operating conditions	22
<b>6</b>	<b>Combining instruments</b>	<b>23</b>
<b>7</b>	<b>Front panel</b>	<b>25</b>

7.1	Channel input connectors	25
7.2	Power indicator	25
<b>8</b>	<b>Rear panel</b>	<b>27</b>
8.1	Power	27
8.1.1	Power adapter	28
8.1.2	USB power cable	28
8.2	USB	28
8.3	Extension Connector	29
8.4	CMI	29
8.5	Ventilation slot	30
<b>9</b>	<b>Specifications</b>	<b>31</b>
9.1	Acquisition system	31
9.2	Acquisition system (continued)	32
9.3	Trigger system	33
9.4	Power	33
9.5	Multi-instrument synchronization	33
9.6	Probe calibration	33
9.7	Physical	34
9.8	I/O connectors	34
9.9	Interface	34
9.10	System requirements	34
9.11	Environmental conditions	34
9.12	Measure leads	35
9.13	Differential attenuators	35
9.14	Certifications and Compliances	35
9.15	Package contents	36

**When working with electricity, no instrument can guarantee complete safety. It is the responsibility of the person who works with the instrument to operate it in a safe way. Maximum security is achieved by selecting the proper instruments and following safe working procedures. Safe working tips are given below:**

- Always work according (local) regulations.
- Work on installations with voltages higher than  $25 V_{AC}$  or  $60 V_{DC}$  should only be performed by qualified personnel.
- Avoid working alone.
- Observe all indications on the Automotive Test Scope ATS6 before connecting any wiring
- Check the probes/test leads for damages. Do **not** use them if they are damaged
- Take care when measuring at voltages higher than  $25 V_{AC}$  or  $60 V_{DC}$ .
- Do not operate the equipment in an explosive atmosphere or in the presence of flammable gases or fumes.
- Do not use the equipment if it does not operate properly. Have the equipment inspected by qualified service personal. If necessary, return the equipment to TiePie engineering for service and repair to ensure that safety features are maintained.



## Declaration of conformity

2

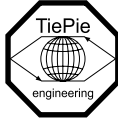

TiePie engineering  
Koperslagersstraat 37  
8601 WL Sneek  
The Netherlands

### EC Declaration of conformity

We declare, on our own responsibility, that the product

#### **Automotive Test Scope ATS610004D-XMSG Automotive Test Scope ATS605004D-XMS**

for which this declaration is valid, is in compliance with

EC directive 2011/65/EU (the RoHS directive)  
including up to amendment 2021/1980,

EC regulation 1907/2006 (REACH)  
including up to amendment 2021/2045,

and with

EN 55011:2016/A1:2017  
EN 55022:2011/C1:2011

IEC 61000-6-1:2019 EN  
IEC 61000-6-3:2007/A1:2011/C11:2012 EN

according the conditions of the EMC standard 2004/108/EC,

also with

Canada: ICES-001:2004

Australia/New Zealand: AS/NZS CISPR 11:2011

and

IEC 61010-1:2010/A1:2019

USA: UL 61010-1, Edition 3

and is categorized as 30 Vrms, 42 Vpk, 60 Vdc

Sneek, 1-3-2017  
ir. A.P.W.M. Poelsma

A handwritten signature in blue ink, appearing to read "A.P.W.M. Poelsma", written over a blue horizontal line.

## Environmental considerations

This section provides information about the environmental impact of the Automotive Test Scope ATS6.

### End-of-life handling

Production of the Automotive Test Scope ATS6 required the extraction and use of natural resources. The equipment may contain substances that could be harmful to the environment or human health if improperly handled at the Automotive Test Scope ATS6's end of life.



In order to avoid release of such substances into the environment and to reduce the use of natural resources, recycle the Automotive Test Scope ATS6 in an appropriate system that will ensure that most of the materials are reused or recycled appropriately.

The shown symbol indicates that the Automotive Test Scope ATS6 complies with the European Union's requirements according to Directive 2002/96/EC on waste electrical and electronic equipment (WEEE).





Before using the Automotive Test Scope ATS6 first read chapter 1 about safety.

Many technicians investigate electrical signals. Though the measurement may not be electrical, the physical variable is often converted to an electrical signal, with a special transducer. Common transducers are accelerometers, pressure probes, current clamps and temperature probes. The advantages of converting the physical parameters to electrical signals are large, since many instruments for examining electrical signals are available.

The Automotive Test Scope ATS6 is a portable four channel measuring instrument with differential inputs. The Automotive Test Scope ATS6 is available in two versions:

- Automotive Test Scope ATS610004D-XMSG
- Automotive Test Scope ATS605004D-XMS

These are almost identical, except for a few differences, which are described later.

The native resolutions are 8, 12 and 14 bits and a user selectable resolution of 16 bits is available too, with adjusted maximum sampling rates:

Measuring		ATS610004D-XMSG	ATS605004D-XMS
Resolution	Channels		
8 bit	1 ch	1 GSa/s	500 MSa/s
	2 ch	500 MSa/s	200 MSa/s
	3 or 4 ch	200 MSa/s	100 MSa/s
12 bit	1 ch	500 MSa/s	200 MSa/s
	2 ch	200 MSa/s	100 MSa/s
	3 or 4 ch	100 MSa/s	50 MSa/s
14 bit		100 MSa/s	50 MSa/s
16 bit		6.25 MSa/s	3.125 MSa/s

Table 3.1: Maximum sampling rates

The Automotive Test Scope ATS6 is delivered with 256 MB total memory, depending on the measurement setup, the amount of memory per channel is:

Measuring		Automotive Test Scope ATS6
Resolution	Channels	
8 bit	1 ch	256 MSa
	2 ch	128 MSa
	3 or 4 ch	64 MSa
12, 14, 16 bit	1 ch	128 MSa
	2 ch	64 MSa
	3 or 4 ch	32 MSa

Table 3.2: Maximum record lengths per channel

The Automotive Test Scope ATS6 supports high speed continuous streaming measurements. The maximum streaming rates when connected to a USB 3.0 port are:

Measuring		ATS610004D-XMSG	ATS605004D-XMS
Resolution	Channels		
8 bit	1 ch	200 MSa/s <sup>1</sup>	100 MSa/s
	2 ch	100 MSa/s <sup>2</sup>	50 MSa/s
	3 or 4 ch	50 MSa/s <sup>3</sup>	25 MSa/s
12 bit	1 ch	100 MSa/s <sup>2</sup>	50 MSa/s
	2 ch	50 MSa/s <sup>3</sup>	25 MSa/s
	3 or 4 ch	25 MSa/s <sup>4</sup>	12.5 MSa/s
14 bit	1 ch	100 MSa/s <sup>2</sup>	50 MSa/s
	2 ch	50 MSa/s <sup>3</sup>	25 MSa/s
	3 or 4 ch	25 MSa/s <sup>4</sup>	12.5 MSa/s
16 bit		6.25 MSa/s <sup>5</sup>	3.125 MSa/s

Table 3.3: Maximum streaming rates

<sup>1</sup> ≤ 40 MSa/s when connected to USB 2.0

<sup>2</sup> ≤ 20 MSa/s when connected to USB 2.0

<sup>3</sup> ≤ 10 MSa/s when connected to USB 2.0

<sup>4</sup> ≤ 5 MSa/s when connected to USB 2.0

<sup>5</sup> ATS610004D-XMSG ≤ 3.125 MSa/s when connected to USB 2.0, measuring 3 or 4 channels

The Automotive Test Scope ATS6 is equipped with **SureConnect** connection test. **SureConnect** connection test tells you immediately whether your test probe or clip actually makes electrical contact or not. No more doubt whether your probe doesn't make contact or there really is no signal. This is useful when surfaces are oxidized and your probe cannot get a good electrical contact. Simply activate the **SureConnect** and you know whether there is contact or not. Also when back probing connectors in confined places, **SureConnect** immediately shows whether the probes make contact or not.



The Automotive Test Scope ATS6 also comes with resistance measurement on all channels. Resistances up to 2 MOhm can be measured directly. Resistance can be shown in meter displays and can also be plotted versus time in a graph, creating an Ohm scope. 

With the **SafeGround** protected ground feature, the differential input of the Automotive Test Scope ATS610004D-XMSG is switched into a ground current protected single ended input. This allows to perform single ended measurements with e.g. an attenuating oscilloscope probe, without the risk of creating a short circuit to ground. **SafeGround** is only available on the Automotive Test Scope ATS610004D-XMSG. 

With the accompanying software the Automotive Test Scope ATS6 can be used as an oscilloscope, a spectrum analyzer, a true RMS voltmeter or a transient recorder. All instruments measure by sampling the input signals, digitizing the values, process them, save them and display them.

### 3.1 Differential input

Most oscilloscopes are equipped with standard, single ended inputs, which are referenced to ground. This means that one side of the input is always connected to ground and the other side to the point of interest in the circuit under test.

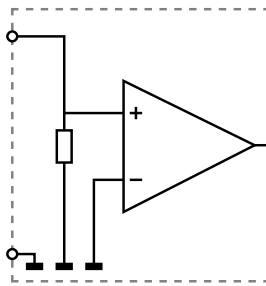

Figure 3.1: Single ended input

Therefore the voltage that is measured with an oscilloscope with standard, single ended inputs is always measured between that specific point and ground.

When the voltage is not referenced to ground, connecting a standard single ended oscilloscope input to the two points would create a short circuit between one of the points and ground, possibly damaging the circuit and the oscilloscope.

A safe way would be to measure the voltage at one of the two points, in reference to ground and at the other point, in reference to ground and then calculate the voltage difference between the two points. On most oscilloscopes this can be done by connecting one of the channels to one point and another channel to the other point and then use the math function CH1 - CH2 in the oscilloscope to display the actual voltage difference.

There are some disadvantages to this method:

- a short circuit to ground can be created when an input is wrongly connected
- to measure one signal, two channels are occupied

- by using two channels, the measurement error is increased, the errors made on each channel will be combined, resulting in a larger total measurement error
- The Common Mode Rejection Ratio (CMRR) of this method is relatively low. If both points have a relative high voltage, but the voltage difference between the two points is small, the voltage difference can only be measured in a high input range, resulting in a low resolution

A much better way is to use an oscilloscope with a differential input.

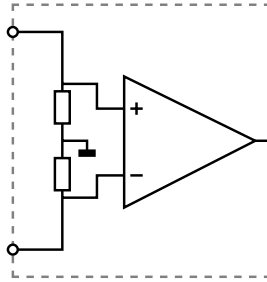

Figure 3.2: Differential input

A differential input is not referenced to ground, but both sides of the input are “floating”. It is therefore possible to connect one side of the input to one point in the circuit and the other side of the input to the other point in the circuit and measure the voltage difference directly.

Advantages of a differential input:

- No risk of creating a short circuit to ground
- Only one channel is required to measure the signal
- More accurate measurements, since only one channel introduces a measurement error
- The CMRR of a differential input is high. If both points have a relative high voltage, but the voltage difference between the two points is small, the voltage difference can be measured in a low input range, resulting in a high resolution

Disadvantages of a differential input:

- Higher sensitivity to external disturbances when used with standard measure leads
- Cannot be used in combination with a standard attenuating oscilloscope probe

### 3.1.1 SafeGround on each channel

The SafeGround protected ground feature of the Automotive Test Scope ATS6 allows to switch the differential inputs to single ended inputs. This enables to

perform single ended measurements as well as using (attenuating) oscilloscope probes. **SafeGround** can be enabled for each channel individually.

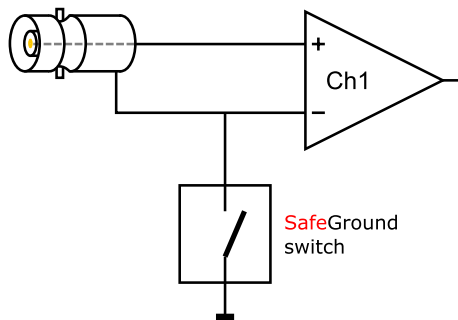



Figure 3.3: SafeGround

A button on each channel toolbar in the software allows to control the **SafeGround** state between differential  and single ended .

When **SafeGround** is enabled for a channel, the input is switched to single ended and the ground current of that input is real time monitored. When the ground current becomes too high (<500 mA), the ground connection is immediately (<100 ns) opened, protecting the input against short circuits to ground. Also a warning dialog is shown:

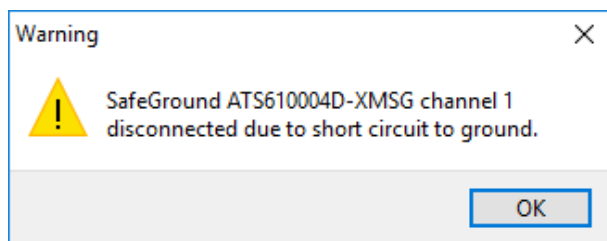

Figure 3.4: SafeGround warning

Once the short circuit is removed, **SafeGround** can be enabled again.

**SafeGround** protects your scope, your computer and your circuit under test against accidental wrong ground connections. The **SafeGround** protected ground feature is optionally available for the Automotive Test Scope ATS6.

### 3.1.2 Differential attenuators

To increase the input range of the Automotive Test Scope ATS6, it comes with a differential 1:10 attenuator for each channel. This differential attenuator is specially designed to be used with the Automotive Test Scope ATS6.



Figure 3.5: Differential attenuator

For a differential input, both sides of the input need to be attenuated.

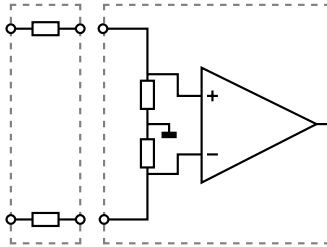

Figure 3.6: Differential attenuator matches with differential input

Standard oscilloscope probes and attenuators only attenuate one side of the signal path. These are not suitable to be used with a differential input. Using these on a differential input will have a negative effect on the CMRR and will introduce measurement errors.

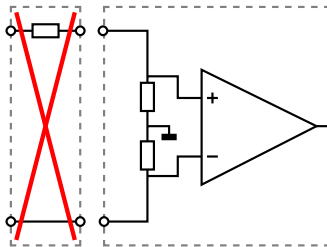

Figure 3.7: Standard probe is mismatch with differential input



The Differential Attenuator and the inputs of the Automotive Test Scope ATS6 are differential, which means that the outside of the BNC's are not grounded, but carry life signals.

When using the attenuator, the following points have to be taken into consideration:

- do not connect other cables to the attenuator than the ones that are supplied with the instrument
- do not touch the metal parts of the BNC's when the attenuator is connected to the circuit under test, they can carry a dangerous voltage. It will also influence the measurements and create measurement errors.
- do not connect the outside of the two BNC's of the attenuator to each other as this will short circuit a part of the internal circuit and will create measurement errors
- do not connect the outside of the BNC's of two or more attenuators that are connected to different channels of the Automotive Test Scope ATS6 to each other
- do not apply excessive mechanical force to the attenuator in any direction (e.g. pulling the cable, using the attenuator as handle to carry the Automotive Test Scope ATS6, etc.)



---

When the Automotive Test Scope ATS6 is equipped with **SafeGround** and the inputs are switched to single ended, using the differential attenuator will lead to significant measurement errors. Use attenuating oscilloscope probes instead.

---

### 3.1.3 Differential test lead

The Automotive Test Scope ATS6 comes with a special differential test lead. This test lead is specially designed to ensure a good CMRR.

The special heat resistant differential test lead provided with the Automotive Test Scope ATS6 is designed to be immune for noise from the surrounding environment.



---

The differential test lead is only immune for noise when used on a differential input. When the Automotive Test Scope ATS6 is equipped with **SafeGround** and the inputs are switched to single ended, the differential test lead will **not** be immune for noise. Use standard shielded test leads or oscilloscope probes instead.

---

## 3.2 Sampling

When sampling the input signal, samples are taken at fixed intervals. At these intervals, the size of the input signal is converted to a number. The accuracy of this number depends on the resolution of the instrument. The higher the resolution, the smaller the voltage steps in which the input range of the instrument is divided. The acquired numbers can be used for various purposes, e.g. to create a graph.

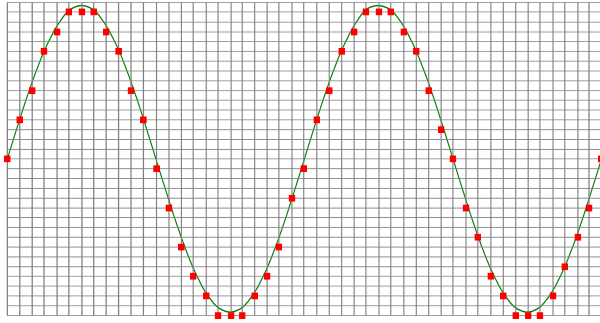

Figure 3.8: Sampling

The sine wave in figure 3.8 is sampled at the dot positions. By connecting the adjacent samples, the original signal can be reconstructed from the samples. You can see the result in figure 3.9.

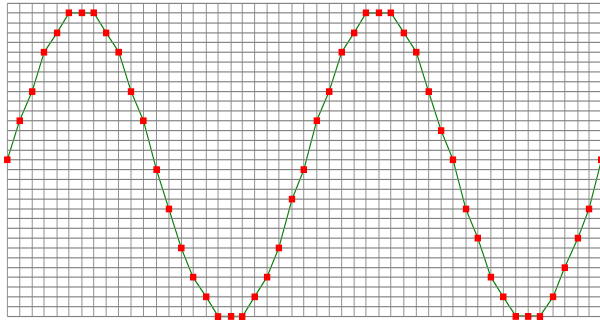

Figure 3.9: "connecting" the samples

### 3.3 Sampling rate

The rate at which the samples are taken is called the **sampling rate**, the number of samples per second. A higher sampling rate corresponds to a shorter interval between the samples. As is visible in figure 3.10, with a higher sampling rate, the original signal can be reconstructed much better from the measured samples.



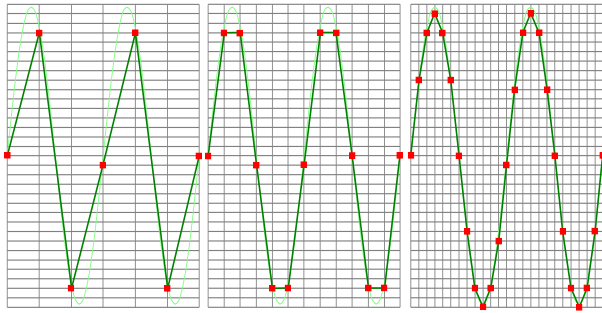

Figure 3.10: The effect of the sampling rate

The sampling rate must be higher than 2 times the highest frequency in the input signal. This is called the **Nyquist frequency**. Theoretically it is possible to reconstruct the input signal with more than 2 samples per period. In practice, 10 to 20 samples per period are recommended to be able to examine the signal thoroughly.

### 3.3.1 Aliasing

When sampling an analog signal with a certain sampling rate, signals appear in the output with frequencies equal to the sum and difference of the signal frequency and multiples of the sampling rate. For example, when the sampling rate is 1000 Sa/s and the signal frequency is 1250 Hz, the following signal frequencies will be present in the output data:

Multiple of sampling rate	1250 Hz signal	-1250 Hz signal
...		
-1000	$-1000 + 1250 = \mathbf{250}$	$-1000 - 1250 = -2250$
0	$0 + 1250 = 1250$	$0 - 1250 = -1250$
1000	$1000 + 1250 = 2250$	$1000 - 1250 = -250$
2000	$2000 + 1250 = 3250$	$2000 - 1250 = 750$
...		

Table 3.4: Aliasing

As stated before, when sampling a signal, only frequencies lower than half the sampling rate can be reconstructed. In this case the sampling rate is 1000 Sa/s, so we can only observe signals with a frequency ranging from 0 to 500 Hz. This means that from the resulting frequencies in the table, we can only see the 250 Hz signal in the sampled data. This signal is called an **alias** of the original signal.

If the sampling rate is lower than twice the frequency of the input signal, **aliasing** will occur. The following illustration shows what happens.

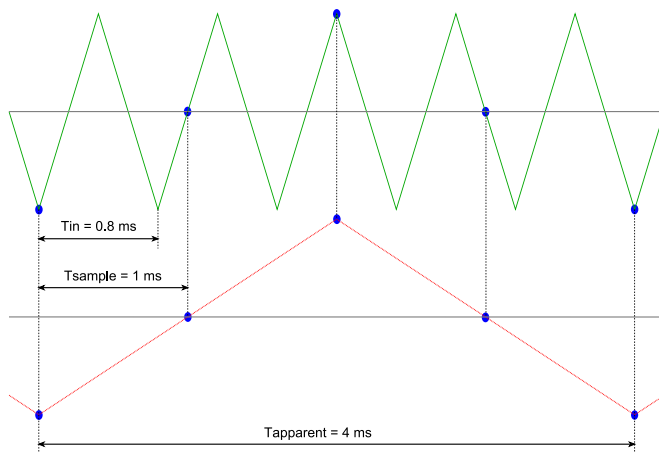

Figure 3.11: Aliasing

In figure 3.11, the green input signal (top) is a triangular signal with a frequency of 1.25 kHz. The signal is sampled with a rate of 1 kSa/s. The corresponding sampling interval is  $1/1000\text{Hz} = 1\text{ms}$ . The positions at which the signal is sampled are depicted with the blue dots. The red dotted signal (bottom) is the result of the reconstruction. The period time of this triangular signal appears to be 4 ms, which corresponds to an apparent frequency (alias) of 250 Hz ( $1.25 \text{ kHz} - 1 \text{ kHz}$ ).



To avoid aliasing, always start measuring at the highest sampling rate and lower the sampling rate if required.

### 3.4 Digitizing

When digitizing the samples, the voltage at each sample time is converted to a number. This is done by comparing the voltage with a number of levels. The resulting number is the number corresponding to the level that is closest to the voltage. The number of levels is determined by the resolution, according to the following relation:  $LevelCount = 2^{Resolution}$ .

The higher the **resolution**, the more levels are available and the more accurate the input signal can be reconstructed. In figure 3.12, the same signal is digitized, using two different amounts of levels: 16 (4-bit) and 64 (6-bit).

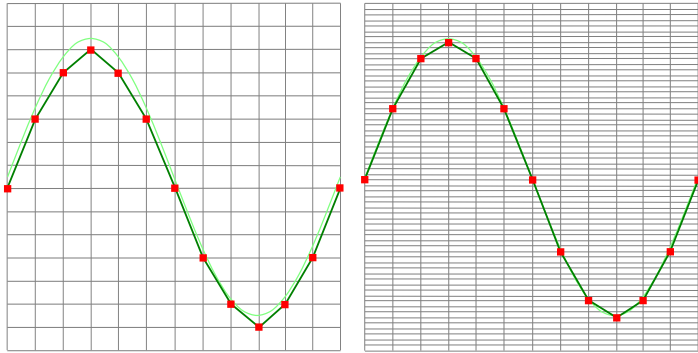

Figure 3.12: The effect of the resolution

The Automotive Test Scope ATS6 measures at e.g. 14 bit resolution ( $2^{14}=16384$  levels). The smallest detectable voltage step depends on the input range. This voltage can be calculated as:

$$\text{VoltageStep} = \text{FullInputRange} / \text{LevelCount}$$

For example, the 200 mV range ranges from -200 mV to +200 mV, therefore the full range is 400 mV. This results in a smallest detectable voltage step of  $0.400 \text{ V} / 16384 = 24.41 \mu\text{V}$ .

### 3.5 Signal coupling

The Automotive Test Scope ATS6 has two different settings for the signal coupling: AC and DC. In the setting DC, the signal is directly coupled to the input circuit. All signal components available in the input signal will arrive at the input circuit and will be measured.

In the setting AC, a capacitor will be placed between the input connector and the input circuit. This capacitor will block all DC components of the input signal and let all AC components pass through. This can be used to remove a large DC component of the input signal, to be able to measure a small AC component at high resolution.



When measuring DC signals, make sure to set the signal coupling of the input to DC.

### 3.6 Probe compensation

When the inputs of the Automotive Test Scope ATS6 are switched to single-ended (SafeGround enabled), standard X1 / X10 attenuating oscilloscope probes can be used. These are 1x/10x selectable passive probes. This means that the input signal is passed through directly or 10 times attenuated.



---

When using an oscilloscope probe in 1:1 the setting, the bandwidth of the probe is only 6 MHz. The full bandwidth of the probe is only obtained in the 1:10 setting

---

The x10 attenuation is achieved by means of an attenuation network. This attenuation network has to be adjusted to the oscilloscope input circuitry, to guarantee frequency independency. This is called the low frequency compensation. Each time a probe is used on an other channel or an other oscilloscope, the probe must be adjusted.

Therefore the probe is equipped with a setscrew, with which the parallel capacity of the attenuation network can be altered. To adjust the probe, switch the probe to the x10 and attach the probe to a 1 kHz square wave signal. This signal is available at pin 3 of the 9 pin extension connector at the rear of the Automotive Test Scope ATS6. Then adjust the probe for a square front corner on the square wave displayed. See also the following illustrations.

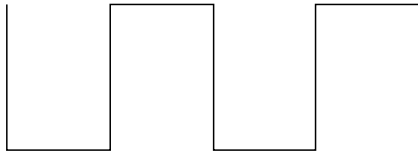

Figure 3.13: correct

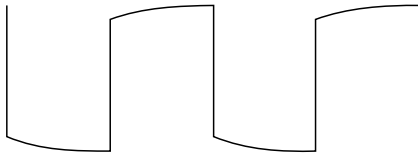

Figure 3.14: under compensated

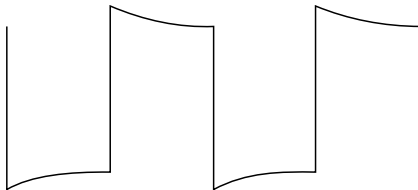

Figure 3.15: over compensated



Before connecting the Automotive Test Scope ATS6 to the computer, the drivers need to be installed.

### 4.1 Introduction

To operate a Automotive Test Scope ATS6, a driver is required to interface between the measurement software and the instrument. This driver takes care of the low level communication between the computer and the instrument, through USB. When the driver is not installed, or an old, no longer compatible version of the driver is installed, the software will not be able to operate the Automotive Test Scope ATS6 properly or even detect it at all.

### 4.2 Computers running Windows 10

When the Automotive Test Scope ATS6 is plugged in into a USB port of the computer, Windows will detect the instrument and will download the required driver from Windows Update. When the download is finished, the driver will be installed automatically.

### 4.3 Computers running Windows 8 or older

The installation of the USB driver is done in a few steps. Firstly, the driver has to be pre-installed by the driver setup program. This makes sure that all required files are located where Windows can find them. When the instrument is plugged in, Windows will detect new hardware and install the required drivers.

#### 4.3.1 Where to find the driver setup

The driver setup program and measurement software can be found in the download section on TiePie engineering's website. It is recommended to install the latest version of the software and USB driver from the website. This will guarantee the latest features are included.

#### 4.3.2 Executing the installation utility

To start the driver installation, execute the downloaded driver setup program. The driver install utility can be used for a first time installation of a driver on a system and also to update an existing driver.

The screen shots in this description may differ from the ones displayed on your computer, depending on the Windows version.

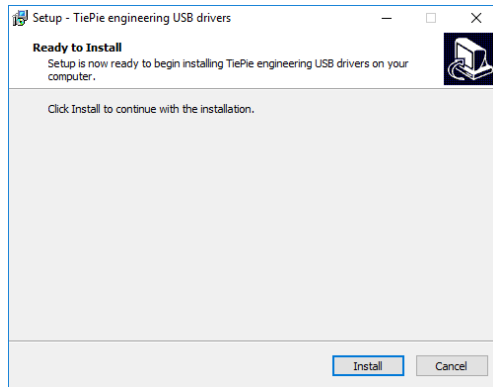

Figure 4.1: Driver install: step 1

When drivers were already installed, the install utility will remove them before installing the new driver. To remove the old driver successfully, **it is essential** that the Automotive Test Scope ATS6 is disconnected from the computer prior to starting the driver install utility. When the Automotive Test Scope ATS6 is used with an external power supply, this must be disconnected too.

Clicking **“Install”** will remove existing drivers and install the new driver. A *remove entry* for the new driver is added to the software applet in the Windows control panel.

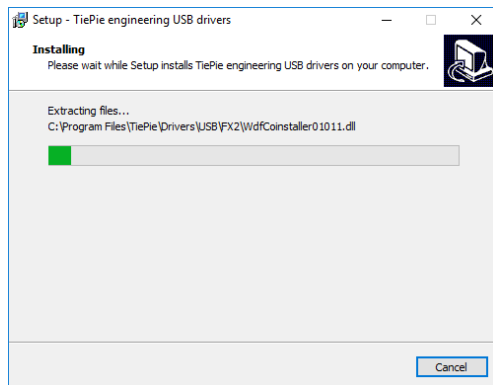

Figure 4.2: Driver install: Copying files

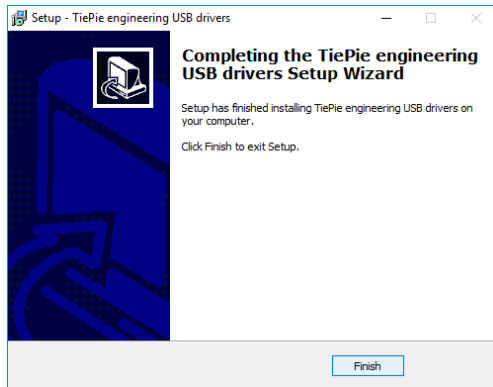

Figure 4.3: Driver install: Finished







Drivers have to be installed before the Automotive Test Scope ATS6 is connected to the computer for the first time. See chapter 4 for more information.

### 5.1 Power the instrument

The Automotive Test Scope ATS6 is powered by the USB, no external power supply is required. Only connect the Automotive Test Scope ATS6 to a bus powered USB port, otherwise it may not get enough power to operate properly.

#### 5.1.1 External power

In certain cases, the Automotive Test Scope ATS6 cannot get enough power from the USB port. When a Automotive Test Scope ATS6 is connected to a USB port, powering the hardware will result in an inrush current higher than the nominal current. After the inrush current, the current will stabilize at the nominal current.

USB ports have a maximum limit for both the inrush current peak and the nominal current. When either of them is exceeded, the USB port will be switched off. As a result, the connection to the Automotive Test Scope ATS6 will be lost.

Most USB ports can supply enough current for the Automotive Test Scope ATS6 to work without an external power supply, but this is not always the case. Some (battery operated) portable computers or (bus powered) USB hubs do not supply enough current. The exact value at which the power is switched off, varies per USB controller, so it is possible that the Automotive Test Scope ATS6 functions properly on one computer, but does not on another.

The Automotive Test Scope ATS6 comes with a universal power supply, that can be connected to a power outlet using the appropriate adapter. The 3.5 mm connector attached to the power supply must be plugged into the power connector at the rear of the Automotive Test Scope ATS6. Refer to paragraph 8.1 for specifications of the external power input.

### 5.2 Connect the instrument to the computer

After the new driver has been pre-installed (see chapter 4), the Automotive Test Scope ATS6 can be connected to the computer. When the Automotive Test Scope ATS6 is connected to a USB port of the computer, Windows will detect new hardware.

Depending on the Windows version, a notification can be shown that new hardware is found and that drivers will be installed. Once ready, Windows will report that the driver is installed.

When the driver is installed, the measurement software can be installed and the Automotive Test Scope ATS6 can be used.

### 5.3 Plug into a different USB port

When the Automotive Test Scope ATS6 is plugged into a different USB port, some Windows versions will treat the Automotive Test Scope ATS6 as different hardware and will install the drivers again for that port. This is controlled by Microsoft Windows and is not caused by TiePie engineering.

### 5.4 Operating conditions

The Automotive Test Scope ATS6 is ready for use as soon as the software is started. However, to achieve rated accuracy, allow the instrument to settle for 20 minutes. If the instrument has been subjected to extreme temperatures, allow additional time for internal temperatures to stabilize. Because of temperature compensated calibration, the Automotive Test Scope ATS6 will settle within specified accuracy regardless of the surrounding temperature.

## Combining instruments

When more channels are required than one instrument can offer, multiple instruments can be combined into a larger combined instrument. To combine two or more instruments, the instruments need to be connected to each other using special cables.

The CMI (Combine Multiple Instruments) interface that is available by default on the Automotive Test Scope ATS6 provides an easy way to couple multiple oscilloscopes to one combined oscilloscope.

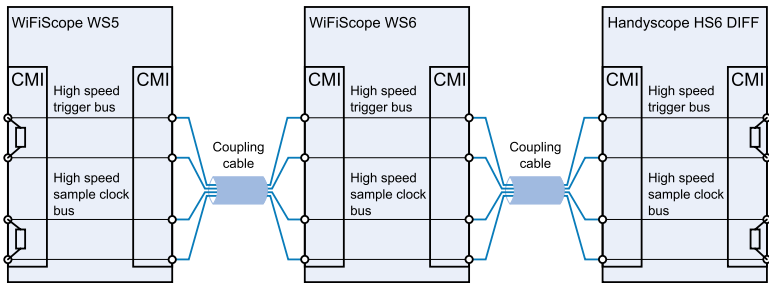

Figure 6.1: CMI diagram

The CMI interface supports automatic recognition of the instrument. The high speed trigger bus is automatically terminated with the correct impedance and the high speed sampling bus is automatically configured and terminated at the beginning and end of the bus. The high speed sampling bus takes care that each Handyscope is fully synchronized to ensure that even at the highest sampling rate the instruments operate at the same sample clock (0 ppm clock error!). The connection order when combining multiple instruments is not important. The CMI interface has built-in intelligence to detect the connections and terminate all buses properly at both ends of the bus. So instruments can be connected to each other in random order. Placing terminators and determining the proper connection order is not required!

Advantages of the CMI (Combine Multiple Instruments) interface are:

- automatic instrument recognition,
- automatic creation and termination of the high speed trigger bus,
- automatic creation and termination of the high speed sampling bus,
- automatic master/slave setting of the sampling clock bus.

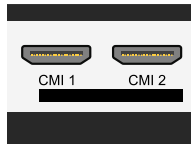

Figure 6.2: CMI connectors

Connecting is done by daisy chaining the CMI connectors of the instruments prior to starting the software, using special coupling cables (order number TP-C50H). The software will detect how the instruments are connected to each other and will automatically terminate the connection bus. The software will combine the connected instruments to one large instrument. The combined instruments will sample using the same clock, with a deviation of 0 ppm.



Figure 6.3: Multiple Automotive Test Scope ATS6s combined

A 20 channel instrument is easily made by connecting five Automotive Test Scope ATS6s to each other.

When combining one or more Automotive Test Scope ATS6s with other instruments including Handyscope HS5s and/or WiFiScope WS5s, the daisy chained CMI bus must begin or end with a Handyscope HS6, Handyscope HS6 DIFF, WiFiScope WS6, WiFiScope WS6 DIFF, Automotive Test Scope ATS610004D-XMSG, Automotive Test Scope ATS605004D-XMS, Automotive Test Scope ATS610004DW-XMSG or Automotive Test Scope ATS605004DW-XMS. Additionally, the maximum sampling rate is limited to 100 MSa/s at 14 bit resolution.

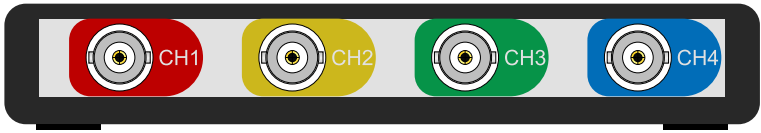

Figure 7.1: Front panel

## 7.1 Channel input connectors

The CH1 – CH4 BNC connectors are the main inputs of the acquisition system. The isolated BNC connectors are not connected to the ground of the Automotive Test Scope ATS6.

## 7.2 Power indicator

A power indicator is situated at the top cover of the instrument. It is lit when the Automotive Test Scope ATS6 is powered.



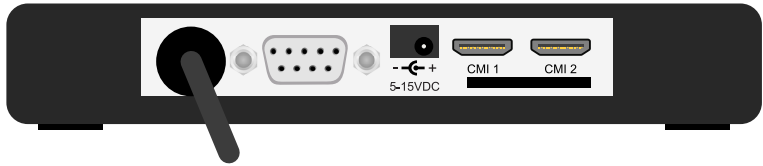

Figure 8.1: Rear panel

## 8.1 Power

The Automotive Test Scope ATS6 is powered through the USB. If the USB cannot supply enough power, it is possible to power the instrument externally. The Automotive Test Scope ATS6 has two external power inputs located at the rear of the instrument: the dedicated power connector and a pin of the 9 pin D-sub extension connector. The specifications of the dedicated power connector are:



Pin	Dimension	Description
Center pin	Ø1.3 mm	positive
Outside bushing	Ø3.5 mm	ground

Figure 8.2: Power connector

To power the instrument through the extension connector, the power has to be applied to pin 7 of the extension connector. Pin 6 can be used as ground. The following minimum and maximum voltages apply to the power inputs:

Minimum	4.5 V <sub>DC</sub> / 2 A max.
Maximum	15 V <sub>DC</sub> / 1 A max.

Table 8.1: Maximum voltages

Note that the externally applied voltage should be higher than the USB voltage to relieve the USB port.

### 8.1.1 Power adapter

The Automotive Test Scope ATS6 comes with an external power adapter that can be connected to any mains power net that supplies 100 – 240 V<sub>AC</sub>, 50 – 60 Hz. The external power adapter can be connected to the dedicated power connector.



Figure 8.3: Power adapter

### 8.1.2 USB power cable

A special USB external power cable is supplied with the Automotive Test Scope ATS6 that can be used instead of a power adapter. One end of this cable can be connected to a second USB port on the computer, the other end can be plugged in the dedicated power connector at the rear of the instrument. The power for the instrument will then be taken from two USB ports.



Figure 8.4: USB power cable

## 8.2 USB

The Automotive Test Scope ATS6 is equipped with a USB 3.0 Super speed (5 Gbit/s) interface with a fixed cable with type A plug. It will also work on a computer with a USB 2.0 interface, but will then operate at 480 Mbit/s.



## 8.3 Extension Connector

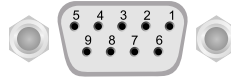

Figure 8.5: Extension connector

A 9 pin female D-sub connector is available at the back of the Automotive Test Scope ATS6 containing the following signals:

Pin	Description	Pin	Description	Pin	Description
1	EXT 1 (LVTTTL)	4	reserved	7	Power IN
2	EXT 2 (LVTTTL)	5	reserved	8	Power OUT
3	Probe Cal	6	GND	9	External Clock in

Table 8.2: Pin description Extension connector

Pins EXT 1 and EXT 2 are equipped with internal 1 kOhm pull-up resistors to 2.5 V. These pins can simultaneously be used as inputs and outputs. Each pin can be configured as external digital trigger input for the acquisition system of the Automotive Test Scope ATS6.

Pin 3, Probe Cal, has a 1 kHz, -1 V to 1 V square wave signal that can be used to perform probe frequency compensations.

Pin 8, Power OUT, has the same potential as the Automotive Test Scope ATS6 power supply. When the Automotive Test Scope ATS6 is USB powered, it is at USB power level. When the Automotive Test Scope ATS6 is externally powered, it is at the same level as the external power input.

The External Clock In signal must be a 10 MHz  $\pm$  1% or a 16.369 MHz  $\pm$  1% 2.5 V TTL signal.

## 8.4 CMI

The Automotive Test Scope ATS6 has two Combine Multiple Instruments interface (CMI) connectors at the rear of the instrument. These are used to combine multiple instruments to a single combined instrument to perform fully synchronized measurements. This requires one TP-C50H coupling cable per two instruments.

They can also be used to get an external sampling clock OUT.



Figure 8.6: CMI connector

Pin	Description
1	GND
2	EXT CLK OUT P (LVDS)
3	EXT CLK OUT N (LVDS)

Table 8.3: Pin description CMI connector



The CMI connectors use HDMI type C sockets, but are not HDMI compliant. They can not be used to connect an HDMI device to the Automotive Test Scope ATS6.

## 8.5 Ventilation slot

Below the two CMI connectors a ventilation slot is located, with a fan behind it.

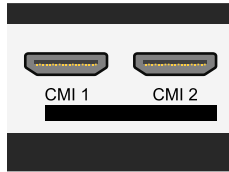

Figure 8.7: Ventilation slot



Do not block the ventilation slot as this may cause the Automotive Test Scope ATS6 becoming too hot.  
Do not insert objects in the ventilation slot as this may damage the fan.

To achieve rated accuracy, allow the instrument to settle for 20 minutes. When subjected to extreme temperatures, allow additional time for internal temperatures to stabilize. Because of temperature compensated calibration, the Automotive Test Scope ATS6 will settle within specified accuracy regardless of the surrounding temperature.

## 9.1 Acquisition system

Number of input channels	4 analog		
CH1, CH2, CH3, CH4	Isolated BNC		
Type	Differential input		
Resolution	8, 12, 14, 16 bit user selectable		
Accuracy	0.25% of full scale $\pm$ 1 LSB		
Ranges (full scale)	$\pm$ 200 mV $\pm$ 2 V $\pm$ 20 V	$\pm$ 400 mV $\pm$ 4 V $\pm$ 40 V	$\pm$ 800 mV $\pm$ 8 V $\pm$ 80 V
Coupling	AC/DC		
Impedance			
SafeGround disabled	2 M $\Omega$ / 12 pF $\pm$ 1 %		
SafeGround enabled	1 M $\Omega$ / 20 pF $\pm$ 1 %		
Maximum voltage	200 V (DC + AC peak <10 kHz)		
Maximum Common Mode voltage	200 mV to 800 mV ranges : 2 V 2 V to 8 V ranges : 20 V 20 V to 80 V ranges : 200 V		
Common Mode Rejection Ratio	-47 dB		
Bandwidth			
-3 dB, at 75 % of full scale	250 MHz		
Limit, selectable per channel	Off (250 MHz) 150 MHz 100 MHz 50 MHz		
AC coupling cut off freq. (-3dB)	$\pm$ 1.5 Hz		
SureConnect			
Maximum voltage on connection	200 V (DC + AC peak <10 kHz)		
Resistance measurement			
Ranges	100 Ohm to 2 MOhm full scale		
Accuracy	1%		
Response time (to 95%)	<10 $\mu$ s		
SafeGround	Only available on ATS610004D-XMSG		
Maximum voltage on connection	200 V (DC + AC peak <10 kHz)		
Maximum switch off current	500 mA		
Response time	<100 ns		

## 9.2 Acquisition system (continued)

Maximum sampling rate	ATS610004D-XMSG	ATS605004D-XMS
8 bit		
Measuring 1 channel	1 GSa/s	500 MSa/s
Measuring 2 channels	500 MSa/s	200 MSa/s
Measuring 3 or 4 channels	200 MSa/s	100 MSa/s
12 bit		
Measuring 1 channel	500 MSa/s	200 MSa/s
Measuring 2 channels	200 MSa/s	100 MSa/s
Measuring 3 or 4 channels	100 MSa/s	50 MSa/s
14 bit	100 MSa/s	50 MSa/s
16 bit	6.25 MSa/s	3.125 MSa/s
Maximum streaming rate <sup>6</sup>	ATS610004D-XMSG	ATS605004D-XMS
8 bit		
Measuring 1 channel	200 MSa/s <sup>1</sup>	100 MSa/s <sup>1</sup>
Measuring 2 channels	100 MSa/s <sup>2</sup>	50 MSa/s <sup>2</sup>
Measuring 3 or 4 channels	50 MSa/s <sup>3</sup>	25 MSa/s <sup>3</sup>
12 bit		
Measuring 1 channel	100 MSa/s <sup>2</sup>	50 MSa/s <sup>2</sup>
Measuring 2 channels	50 MSa/s <sup>3</sup>	25 MSa/s <sup>3</sup>
Measuring 3 or 4 channels	25 MSa/s <sup>4</sup>	12.5 MSa/s <sup>4</sup>
14 bit		
Measuring 1 channel	100 MSa/s <sup>2</sup>	50 MSa/s <sup>2</sup>
Measuring 2 channels	50 MSa/s <sup>3</sup>	25 MSa/s <sup>3</sup>
Measuring 3 or 4 channels	25 MSa/s <sup>4</sup>	12.5 MSa/s <sup>4</sup>
16 bit	6.25 MSa/s <sup>5</sup>	3.125 MSa/s
	<sup>1</sup> ≤ 40 MSa/s when connected to USB 2.0	
	<sup>2</sup> ≤ 20 MSa/s when connected to USB 2.0	
	<sup>3</sup> ≤ 10 MSa/s when connected to USB 2.0	
	<sup>4</sup> ≤ 5 MSa/s when connected to USB 2.0	
	<sup>5</sup> ATS610004D-XMSG ≤ 3.125 MSa/s when connected to USB 2.0, measuring ≥ 3 channels	
	<sup>6</sup> On some computers, the highest streaming rates may not be available, due to computer restrictions.	
Sampling source		
Internal	TCXO	
Accuracy	±0.0001%	
Stability	±1 ppm over 0 °C to +55 °C	
Time base aging	±1 ppm per year time base aging	
External	LVDS, on CMI connectors	
Input range	10 MHz ±1 % 16.369 MHz ±1 %	
Memory, per channel	8 bit	12, 14, 16 bit
Measuring 1 channel	256 MSa	128 MSa
Measuring 2 channels	128 MSa	64 MSa
Measuring 3 or 4 channels	64 MSa	32 MSa

## 9.3 Trigger system

System	Digital, 2 levels
Source	CH1, CH2, CH3, CH4, digital external, OR
Trigger modes	Rising edge, falling edge, any edge, inside window, outside window, enter window, exit window, pulse width
Level adjustment	0 to 100% of full scale
Hysteresis adjustment	0 to 100% of full scale
Resolution	0.024 % (12 bits)/0.006 % (14/16 bits)
Pre trigger	0 to selected record length, 1 sample resolution
Post trigger	0 to selected record length, 1 sample resolution
Trigger hold-off	0 to 64 MSamples, 1 sample resolution
Trigger delay	0 to 16 GSamples, 1 sample resolution
Digital external trigger	
Input	Extension connector pins 1 and 2
Range	0 to 2.5 V (TTL)
Coupling	DC
Jitter	$\leq 1$ sample

## 9.4 Power

Power	From USB or external input
Consumption	5 V <sub>DC</sub> , 1200 mA max
Power adapter	External
Input	110 to 240 V <sub>AC</sub> , 50 to 60 Hz 0.85 A Max., 50 VA to 80 VA
Output	5.5 V <sub>DC</sub> , 2 A
Dimension	
Height	30 mm / 1.2"
Width	45 mm / 1.8"
Length	75 mm / 3"
Order number	TP-UE15WCP1-055200SPA
Replaceable mains plugs for	EU, US, AU, UK

## 9.5 Multi-instrument synchronization

Maximum number of instruments	Limited by available number of USB ports
Synchronization accuracy	0 ppm

## 9.6 Probe calibration

Output	Extension connector pins 3 (signal) and 6 (ground)
Signal	Square wave
Level	-1 V to 1 V
Frequency	1 kHz

## 9.7 Physical

Height	25 mm / 1.0"
Length	170 mm / 6.7"
Width	140 mm / 5.2"
Weight	500 g / 17 ounce
USB cord length	1.8 m / 70"

## 9.8 I/O connectors

CH1, CH2, CH3, CH4	Isolated BNC
USB	Fixed cable with USB 3.0 type A plug, 1.8 m
Extension connector	D-sub 9 pins female
Power	3.5 mm power socket
CMI connectors 1–2	HDMI type C socket

## 9.9 Interface

Interface	USB 3.0 SuperSpeed (5 Gbit/s) (USB 2.0 HighSpeed (480 Mbit/s) compatible)
-----------	--

## 9.10 System requirements

PC I/O connection	USB 2.0, USB 3.0 or USB 3.1
Operating System	Windows 10, 32 and 64 bits

## 9.11 Environmental conditions

Operating	
Ambient temperature	20 °C to 25 °C (10 °C to 40 °C without specifications)
Relative humidity	10 to 90% non condensing
Storage	
Ambient temperature	-20 °C to 70 °C
Relative humidity	5 to 95% non condensing

## 9.12 Measure leads

Model	TP-C1812B
Type	Differential
Connectors	
Instrument side	Isolated male BNC connector
Test point side	Red and black 4 mm shrouded banana plugs
Bandwidth	7 MHz
Safety	CAT III, 1000 V, double isolated
Dimensions	
Total length	3000 mm
Length to split	1800 mm
Length individual ends	1200 mm
Weight	80 g
Color	Black
Heat resistant	Yes
Certification and compliances	
CE conformity	Yes
RoHS	Yes
Accessories	
Color coding rings	5 x 3 rings, various colors
Suitable instrument	Automotive Test Scope ATS6

## 9.13 Differential attenuators

Model	TP-DA10
Attenuation	10 x, differential
Bandwidth	25 MHz
Input impedance	10 M $\Omega$ // 15 pF
Maximum input voltage	300 V
Input connector	Female BNC
Output connector	Male BNC
Dimensions	
Length	79 mm
Diameter	19 mm
Weight	30 g
Suitable instrument	Automotive Test Scope ATS6

## 9.14 Certifications and Compliances

CE mark compliance	Yes
RoHS	Yes
REACH	Yes
EN 55011:2016/A1:2017	Yes
EN 55022:2011/C1:2011	Yes
IEC 61000-6-1:2019 EN	Yes
IEC 61000-6-3:2007/A1:2011/C11:2012	Yes
ICES-001:2004	Yes
AS/NZS CISPR 11:2011	Yes
IEC 61010-1:2010/A1:2019	Yes
UL 61010-1, Edition 3	Yes

## 9.15 Package contents

Instrument	Automotive Test Scope ATSG
Measure leads	4 x Measure lead TP-C1812B, Differential BNC to 4 mm banana plug, 3 m long
Differential attenuator	4 x Differential Attenuator TP-DA10
Alligator clips, large	8 x Alligator Clip TP-AC80L: green, blue, yellow, red and 4 x black
Alligator clips, medium	8 x Alligator Clip TP-AC10L: green, blue, yellow, red and 4 x black
Alligator clips, small	8 x Alligator Clip TP-AC5: green, blue, yellow, red and 4 x black
Accessories	External power adapter USB power cable
Software	Windows 10, 32 and 64 bits, via website
Drivers	Windows 10, 32 and 64 bits, via website
Software Development Kit	Windows 10 and Linux, via website
Manual	Instrument manual and software manual



If you have any suggestions and/or remarks regarding this manual, please contact:

TiePie engineering  
Koperslagersstraat 37  
8601 WL SNEEK  
The Netherlands

Tel.: +31 515 415 416  
Fax: +31 515 418 819  
E-mail: [support@tiepie.nl](mailto:support@tiepie.nl)  
Site: [www.tiepie.com](http://www.tiepie.com)



