

WiFiScope WS5

User manual

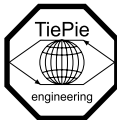

USB
Network
WiFi
Battery power



TiePie engineering

ATTENTION!

Measuring directly on the **line voltage** can be very dangerous.

The **outside** of the **BNC connectors** at the WiFiScope WS5 are connected with the **ground** of the computer. Use a good isolation transformer or a differential probe when measuring at the **line voltage** or at **grounded power supplies!** A short-circuit current will flow if the **ground** of the WiFiScope WS5 is connected to a positive voltage. This short-circuit current can damage both the WiFiScope WS5 and the computer.

Copyright ©2021 TiePie engineering.
All rights reserved.

Revision 2.34, August 2021

Despite the care taken for the compilation of this user manual, TiePie engineering can not be held responsible for any damage resulting from errors that may appear in this manual.

Contents

1	Welcome	1
2	Safety	3
3	Declaration of conformity	5
4	Introduction	7
4.1	Sampling	9
4.2	Sampling rate	9
4.2.1	Aliasing	10
4.3	Digitizing	11
4.4	Signal coupling	12
4.5	Probe compensation	12
5	Driver installation	15
5.1	Introduction	15
5.2	Computers running Windows 10	15
5.3	Computers running Windows 8 or older	15
5.3.1	Where to find the driver setup	15
5.3.2	Executing the installation utility	15
6	Hardware installation	19
6.1	Power the instrument	19
6.1.1	Charging the battery	20
6.1.2	Long term storage	20
6.2	Instrument operation mode	21
6.3	Connect via LAN	22
6.4	Connect via WiFi	23
6.4.1	The computer/laptop has WiFi	23
6.4.2	The computer/laptop has NO WiFi	24
6.5	Connect via USB	26
6.5.1	Plug into a different USB port	26
6.6	Operating conditions	26

7	Combining instruments	27
8	Front panel	31
8.1	CH1 and CH2 input connectors	31
8.2	AWG output connector	31
8.3	Power/Mode button	31
8.4	Status indicators	31
8.4.1	Status	32
8.4.2	LAN	32
8.4.3	WiFi	32
8.4.4	USB	32
8.4.5	Batt	32
9	Rear panel	33
9.1	Power	33
9.1.1	Power adapter	34
9.2	USB	34
9.3	LAN	34
9.4	Extension Connector	35
9.5	CMI	35
9.6	Factory reset	36
9.7	Ventilation slots	36
10	Specifications	37
10.1	Acquisition system	37
10.2	Acquisition system - continued	38
10.3	Trigger system	38
10.4	Arbitrary Waveform Generator	39
10.5	Power	41
10.6	Multi-instrument synchronization	41
10.7	Physical	41
10.8	I/O connectors	41
10.9	Interface	42
10.10	System requirements	42
10.11	Environmental conditions	42
10.12	Certifications and Compliances	42

10.13 Probes	42
10.14 Package contents	43
10.15 Warranty	43



Wireless measuring has now become a reality with the WiFiScope WS5. If a large distance needs to be bridged between the measuring instrument and the PC, the WiFiScope WS5 is the solution for this. Fast measurements and high speed data acquisition are now possible wherever the WiFiScope WS5 is located in the world.

- Because the WiFiScope WS5 is battery-powered, it can be used stand-alone for a long time.
- For measurements in hazardous situations or places where it is not accessible to people for long, the WiFiScope WS5 offers the solution.
- A connection via WiFi or Network (LAN or WAN with possibly POE) gives the user the possibility to place the measuring instrument where this was previously not possible.
- Collecting and viewing measurement data from different locations on a PC / Laptop is now a possibility because the software supports more WiFiScopes at the same time.
- With the very extensive software package, most measurements can be performed.
- A large library of presets is available so that a novice user can immediately perform advanced measurements with a few mouse clicks.
- The WiFiScope WS5 has two analogue inputs with a maximum bandwidth of 250 MHz and an AWG (analogue output) with a maximum sampling speed of 240 MSa/s and a signal frequency of 40 MHz.
- With a WiFi connection, the WiFiScope WS5 is no longer directly connected to the PC or laptop and short circuits are excluded, this eliminates the fear that something will happen to the PC or Laptop.
- A big advantage of the WiFiScopes is that no ground loops can occur. In traditional measurement systems, ground loops give many problems, resulting in unreliable measurement results. With the WiFiScope, because of the absence of ground loops, long distance remote measurements are possible without the results being influenced by ground loops. Also on short distances the absence of ground loops is important for performing reliable measurements. The WiFiScope prevents ground loops from forming so that the measurement speed and resolution are not affected and the measurements remain reliable.
- Integrating the WiFiScope WS5 in your own software environment is supported by an API with examples so that the WiFiScope WS5 can be widely used
- Thanks to a very good hardware structure and advanced software drivers, the WiFiScope WS5 is suitable for high speed data acquisition up to speeds of 5 MSa/s and measurements up to 500 MSa/s with a record length of 32 MSamples of memory per channel with a resolution of 12 to 16 bit.

When working with electricity, no instrument can guarantee complete safety. It is the responsibility of the person who works with the instrument to operate it in a safe way. Maximum security is achieved by selecting the proper instruments and following safe working procedures. Safe working tips are given below:

- Always work according (local) regulations.
- Work on installations with voltages higher than 25 V_{AC} or 60 V_{DC} should only be performed by qualified personnel.
- Avoid working alone.
- Observe all indications on the WiFiScope WS5 before connecting any wiring
- Check the probes/test leads for damages. Do **not** use them if they are damaged
- Take care when measuring at voltages higher than 25 V_{AC} or 60 V_{DC}.
- Do not operate the equipment in an explosive atmosphere or in the presence of flammable gases or fumes.
- Do not use the equipment if it does not operate properly. Have the equipment inspected by qualified service personal. If necessary, return the equipment to TiePie engineering for service and repair to ensure that safety features are maintained.
- Measuring directly on the **line voltage** can be very dangerous. The **outside** of the **BNC connectors** at the WiFiScope WS5 are connected with the **ground** of the computer. Use a good isolation transformer or a differential probe when measuring at the **line voltage** or at **grounded power supplies!** A short-circuit current will flow if the **ground** of the WiFiScope WS5 is connected to a positive voltage. This short-circuit current can damage both the WiFiScope WS5 and the computer.

Declaration of conformity

3

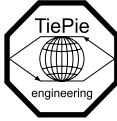

TiePie engineering
Koperslagersstraat 37
8601 WL Sneek
The Netherlands

EC Declaration of conformity

We declare, on our own responsibility, that the product

WiFiScope WS5-540(XM/S/XMS)
WiFiScope WS5-530(XM/S/XMS)
WiFiScope WS5-220(XM/S/XMS)

for which this declaration is valid, is in compliance with

EC directive 2011/65/EU (the RoHS directive)
including up to amendment 2019/178,

and with

EN 55011:2016/A1:2017 IEC 61000-6-1:2019 EN
EN 55022:2011/C1:2011 IEC 61000-6-3:2007/A1:2011/C11:2012 EN

according the conditions of the EMC standard 2004/108/EC,

also with

Canada: ICES-001:2004 Australia/New Zealand: AS/NZS CISPR 11:2011

and

IEC 61010-1:2010/A1:2019 USA: UL 61010-1, Edition 3

and is categorized as 30 Vrms, 42 Vpk, 60 Vdc

Sneek, 15-9-2019
ir. A.P.W.M. Poelsma

A handwritten signature in blue ink, appearing to read "A.P.W.M. Poelsma", written over a blue horizontal line.

FCC statement

FCC 15.119

This device complies with Part 15 of FCC Rules. Operation is Subject to following two conditions:

1. This device may not cause harmful interference, and
2. This device must accept any interference received including interference that cause undesired operation.

FCC 15.105

This equipment has been tested and found to comply within the limits for a Class B digital device, pursuant to part 15 of the FCC Rules. These limits are designed to provide reasonable protection against harmful interference in a residential installation. This equipment generates, uses, and can radiate radio frequency energy and, if not installed and used in accordance with the instructions, may cause harmful interference to radio communications. However, there is no guarantee that interference will not occur in a particular installation. If this equipment does cause harmful interference to radio or television reception, which can be determined by turning the equipment off and on, the user is encouraged to try to correct the interference by one or more of the following measures:

- Reorient or relocate the receiving antenna
- Increase the separation between the equipment and receiver
- Connect the equipment into an outlet on a different circuit from that to which the receiver is connected.
- Consult the dealer or an experienced radio/TV technician for help.

Any changes or modifications not expressly approved by TiePie engineering can void the authority to operate equipment.

This equipment complies with FCC radiation exposure limits set forth for an uncontrolled environment. This equipment should be installed and operated with minimum distance of 20cm between the radiator and your body

Environmental considerations

This section provides information about the environmental impact of the WiFiScope WS5.

End-of-life handling

Production of the WiFiScope WS5 required the extraction and use of natural resources. The equipment may contain substances that could be harmful to the environment or human health if improperly handled at the WiFiScope WS5's end of life.



In order to avoid release of such substances into the environment and to reduce the use of natural resources, recycle the WiFiScope WS5 in an appropriate system that will ensure that most of the materials are reused or recycled appropriately.

The shown symbol indicates that the WiFiScope WS5 complies with the European Union's requirements according to Directive 2002/96/EC on waste electrical and electronic equipment (WEEE).



Before using the WiFiScope WS5 first read chapter 2 about safety.

Many technicians investigate electrical signals. Though the measurement may not be electrical, the physical variable is often converted to an electrical signal, with a special transducer. Common transducers are accelerometers, pressure probes, current clamps and temperature probes. The advantages of converting the physical parameters to electrical signals are large, since many instruments for examining electrical signals are available.

The WiFiScope WS5 is a portable two channel measuring instrument with Arbitrary Waveform Generator. It can be connected to the computer via USB, wired ethernet and WiFi. When used via WiFi, the WiFiScope WS5 can be connected to an existing WiFi network or can act as access point to create its own WiFi network.

The WiFiScope WS5 is equipped with a built-in battery for wireless operation, but can also be powered by an external power supply (included in the package) or via the USB interface.

The WiFiScope WS5 is available in several models with different maximum sampling rates: 200 MSa/s or 500 MSa/s. The native resolutions are 8, 12 and 14 bits and a user selectable resolution of 16 bits is available too, with adjusted maximum sampling rates:

WiFiScope WS5	Channels	Resolution		
		8 / 12 bit	14 bit	16 bit
Model 540	CH1	500 MSa/s	100 MSa/s	6.25 MSa/s
	CH1+CH2	200 MSa/s		
Model 530	CH1	500 MSa/s	100 MSa/s	6.25 MSa/s
	CH1+CH2	200 MSa/s		
Model 220	CH1	200 MSa/s	50 MSa/s	3.125 MSa/s
	CH1+CH2	100 MSa/s		

Table 4.1: Maximum sampling rates

The WiFiScope WS5 supports high speed continuous streaming measurements. The maximum streaming rates are:

WiFiScope WS5	Channels	Resolution		
		8 bit	12/14 bit	16 bit
Model 540	CH1	40 MSa/s	20 MSa/s	6.25 MSa/s
	CH1+CH2	20 MSa/s	10 MSa/s	
Model 530	CH1	40 MSa/s	20 MSa/s	6.25 MSa/s
	CH1+CH2	20 MSa/s	10 MSa/s	
Model 220	CH1	20 MSa/s	10 MSa/s	3.125 MSa/s
	CH1+CH2	10 MSa/s	5 MSa/s	

Table 4.2: Maximum streaming rates

These maximum streaming rates are only achieved when using the WiFiScope WS5 via its USB interface. When used as wired network instrument, maximum streaming rates may be lower, depending on network speed and load. When used via WiFi, maximum streaming rates will be lower and will depend on WiFi signal strength, distance to access point and network load.

The WiFiScope WS5 is available with two memory configurations, these are:

WiFiScope WS5	Standard	With XM option
Model 540	128 KiSa	32 MiSa
Model 530	128 KiSa	32 MiSa
Model 220	128 KiSa	32 MiSa

Table 4.3: Maximum record lengths per channel

Optionally available for the WiFiScope WS5 is **SureConnect** connection test. **SureConnect** connection test tells you immediately whether your test probe or clip actually makes electrical contact or not. No more doubt whether your probe doesn't make contact or there really is no signal. This is useful when surfaces are oxidized and your probe cannot get a good electrical contact. Simply activate the **SureConnect** and you know whether there is contact or not. Also when back probing connectors in confined places, **SureConnect** immediately shows whether the probes make contact or not. 

Models of the WiFiScope WS5 with **SureConnect** come with resistance measurement on all channels. Resistances up to 2 MOhm can be measured directly. Resistance can be shown in meter displays and can also be plotted versus time in a graph, creating an Ohm scope. 

With the accompanying software the WiFiScope WS5 can be used as an oscilloscope, a spectrum analyzer, a true RMS voltmeter or a transient recorder. All instruments measure by sampling the input signals, digitizing the values, process them, save them and display them.

4.1 Sampling

When sampling the input signal, samples are taken at fixed intervals. At these intervals, the size of the input signal is converted to a number. The accuracy of this number depends on the resolution of the instrument. The higher the resolution, the smaller the voltage steps in which the input range of the instrument is divided. The acquired numbers can be used for various purposes, e.g. to create a graph.

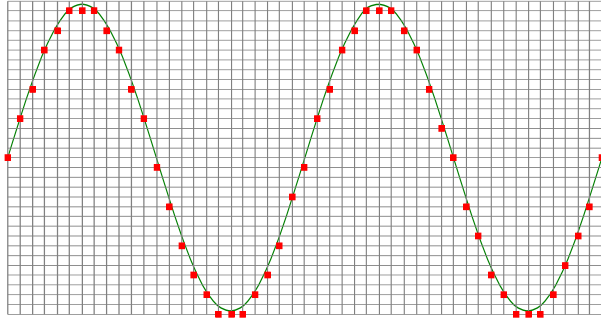

Figure 4.1: Sampling

The sine wave in figure 4.1 is sampled at the dot positions. By connecting the adjacent samples, the original signal can be reconstructed from the samples. You can see the result in figure 4.2.

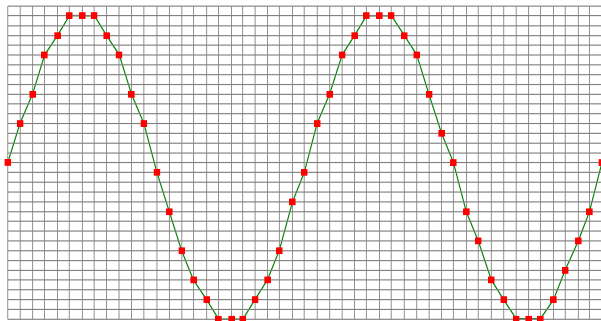

Figure 4.2: "connecting" the samples

4.2 Sampling rate

The rate at which the samples are taken is called the **sampling rate**, the number of samples per second. A higher sampling rate corresponds to a shorter interval between the samples. As is visible in figure 4.3, with a higher sampling rate, the original signal can be reconstructed much better from the measured samples.

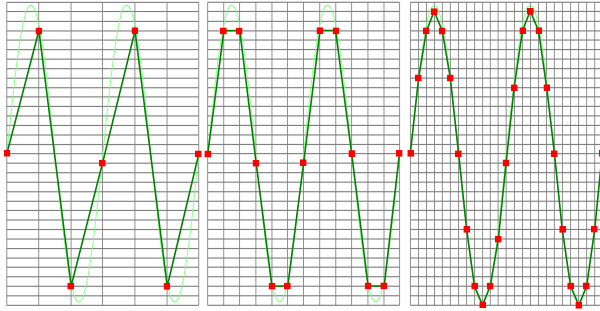

Figure 4.3: The effect of the sampling rate

The sampling rate must be higher than 2 times the highest frequency in the input signal. This is called the **Nyquist frequency**. Theoretically it is possible to reconstruct the input signal with more than 2 samples per period. In practice, 10 to 20 samples per period are recommended to be able to examine the signal thoroughly.

4.2.1 Aliasing

When sampling an analog signal with a certain sampling rate, signals appear in the output with frequencies equal to the sum and difference of the signal frequency and multiples of the sampling rate. For example, when the sampling rate is 1000 Sa/s and the signal frequency is 1250 Hz, the following signal frequencies will be present in the output data:

Multiple of sampling rate	1250 Hz signal	-1250 Hz signal
...		
-1000	$-1000 + 1250 = \mathbf{250}$	$-1000 - 1250 = -2250$
0	$0 + 1250 = 1250$	$0 - 1250 = -1250$
1000	$1000 + 1250 = 2250$	$1000 - 1250 = -250$
2000	$2000 + 1250 = 3250$	$2000 - 1250 = 750$
...		

Table 4.4: Aliasing

As stated before, when sampling a signal, only frequencies lower than half the sampling rate can be reconstructed. In this case the sampling rate is 1000 Sa/s, so we can only observe signals with a frequency ranging from 0 to 500 Hz. This means that from the resulting frequencies in the table, we can only see the 250 Hz signal in the sampled data. This signal is called an **alias** of the original signal.

If the sampling rate is lower than twice the frequency of the input signal, **aliasing** will occur. The following illustration shows what happens.

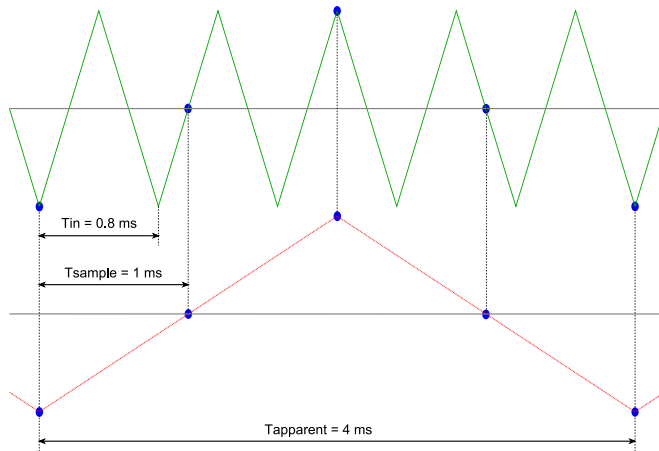

Figure 4.4: Aliasing

In figure 4.4, the green input signal (top) is a triangular signal with a frequency of 1.25 kHz. The signal is sampled with a rate of 1 kSa/s. The corresponding sampling interval is $1/1000\text{Hz} = 1 \text{ ms}$. The positions at which the signal is sampled are depicted with the blue dots. The red dotted signal (bottom) is the result of the reconstruction. The period time of this triangular signal appears to be 4 ms, which corresponds to an apparent frequency (alias) of 250 Hz ($1.25 \text{ kHz} - 1 \text{ kHz}$).



To avoid aliasing, always start measuring at the highest sampling rate and lower the sampling rate if required.

4.3 Digitizing

When digitizing the samples, the voltage at each sample time is converted to a number. This is done by comparing the voltage with a number of levels. The resulting number is the number corresponding to the level that is closest to the voltage. The number of levels is determined by the resolution, according to the following relation: $LevelCount = 2^{Resolution}$.

The higher the **resolution**, the more levels are available and the more accurate the input signal can be reconstructed. In figure 4.5, the same signal is digitized, using two different amounts of levels: 16 (4-bit) and 64 (6-bit).

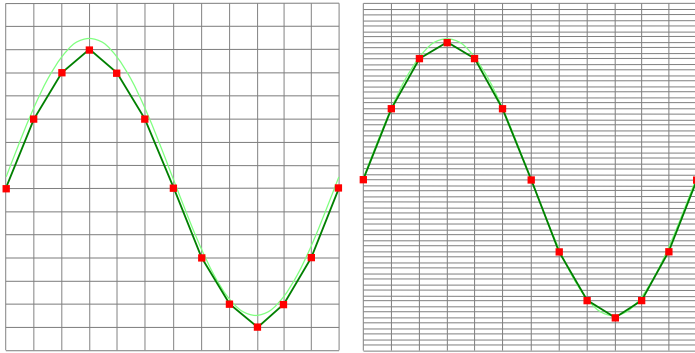

Figure 4.5: The effect of the resolution

The WiFiScope WS5 measures at e.g. 14 bit resolution ($2^{14}=16384$ levels). The smallest detectable voltage step depends on the input range. This voltage can be calculated as:

$$\text{VoltageStep} = \text{FullInputRange} / \text{LevelCount}$$

For example, the 200 mV range ranges from -200 mV to +200 mV, therefore the full range is 400 mV. This results in a smallest detectable voltage step of $0.400 \text{ V} / 16384 = 24.41 \mu\text{V}$.

4.4 Signal coupling

The WiFiScope WS5 has two different settings for the signal coupling: AC and DC. In the setting DC, the signal is directly coupled to the input circuit. All signal components available in the input signal will arrive at the input circuit and will be measured.

In the setting AC, a capacitor will be placed between the input connector and the input circuit. This capacitor will block all DC components of the input signal and let all AC components pass through. This can be used to remove a large DC component of the input signal, to be able to measure a small AC component at high resolution.



When measuring DC signals, make sure to set the signal coupling of the input to DC.

4.5 Probe compensation

The WiFiScope WS5 is shipped with a probe for each input channel. These are 1x/10x selectable passive probes. This means that the input signal is passed through directly or 10 times attenuated.



When using an oscilloscope probe in 1:1 the setting, the bandwidth of the probe is only 6 MHz. The full bandwidth of the probe is only obtained in the 1:10 setting

The x10 attenuation is achieved by means of an attenuation network. This attenuation network has to be adjusted to the oscilloscope input circuitry, to guarantee frequency independency. This is called the low frequency compensation. Each time a probe is used on an other channel or an other oscilloscope, the probe must be adjusted.

Therefore the probe is equipped with a setscrew, with which the parallel capacity of the attenuation network can be altered. To adjust the probe, switch the probe to the x10 and attach the probe to a 1 kHz square wave signal. Then adjust the probe for a square front corner on the square wave displayed. See also the following illustrations.

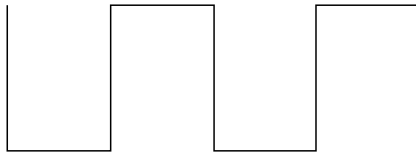

Figure 4.6: correct

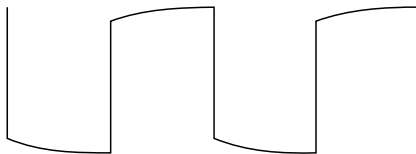

Figure 4.7: under compensated

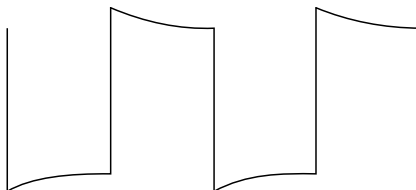

Figure 4.8: over compensated



Before connecting the WiFiScope WS5 to the computer via USB, the drivers need to be installed.

5.1 Introduction

To operate a WiFiScope WS5 via USB, a driver is required to interface between the measurement software and the instrument. This driver takes care of the low level communication between the computer and the instrument, through USB. When the driver is not installed, or an old, no longer compatible version of the driver is installed, the software will not be able to operate the WiFiScope WS5 properly or even detect it at all.

5.2 Computers running Windows 10

When the WiFiScope WS5 is plugged in into a USB port of the computer, Windows will detect the instrument and will download the required driver from Windows Update. When the download is finished, the driver will be installed automatically.

5.3 Computers running Windows 8 or older

The installation of the USB driver is done in a few steps. Firstly, the driver has to be pre-installed by the driver setup program. This makes sure that all required files are located where Windows can find them. When the instrument is plugged in, Windows will detect new hardware and install the required drivers.

5.3.1 Where to find the driver setup

The driver setup program and measurement software can be found in the download section on TiePie engineering's website. It is recommended to install the latest version of the software and USB driver from the website. This will guarantee the latest features are included.

5.3.2 Executing the installation utility

To start the driver installation, execute the downloaded driver setup program. The driver install utility can be used for a first time installation of a driver on a system and also to update an existing driver.

The screen shots in this description may differ from the ones displayed on your computer, depending on the Windows version.

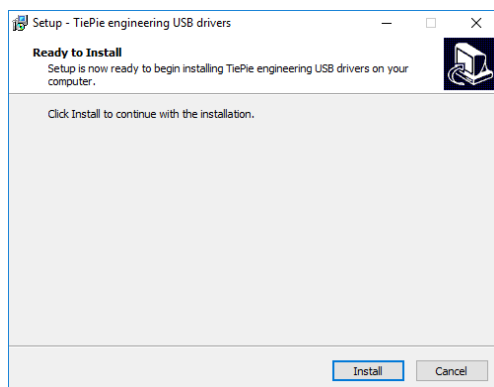

Figure 5.1: Driver install: step 1

When drivers were already installed, the install utility will remove them before installing the new driver. To remove the old driver successfully, **it is essential** that the WiFiScope WS5 is disconnected from the computer prior to starting the driver install utility. When the WiFiScope WS5 is used with an external power supply, this must be disconnected too.

Clicking *“Install”* will remove existing drivers and install the new driver. A *remove entry* for the new driver is added to the software applet in the Windows control panel.

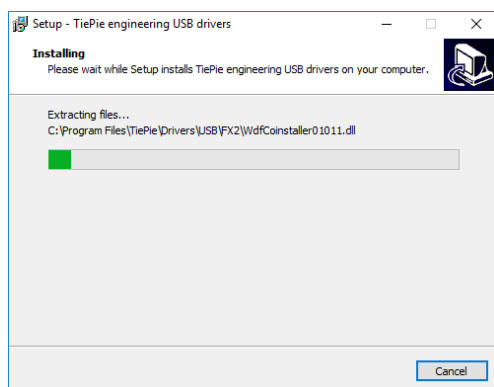

Figure 5.2: Driver install: Copying files

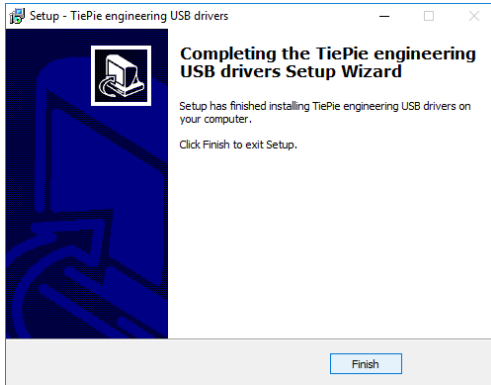

Figure 5.3: Driver install: Finished



Drivers have to be installed before the WiFiScope WS5 is connected to the computer via USB for the first time. See chapter 5 for more information.

6.1 Power the instrument

The WiFiScope WS5 can be powered in three different ways:

- by its built-in battery
- via an external power adapter, connected to the dedicated power input at the rear panel
- via the USB interface

When using the WiFiScope WS5 via its battery, no external power is required. The power consumption of the WiFiScope WS5 depends heavily on the settings of the instrument, when using higher sampling rates the instrument uses more power. Also when using larger record lengths, the power consumption increases. And when the Arbitrary Waveform Generator is used, this also increases the power consumption. It is therefore not possible to give an exact operating time when running on its battery. When the battery is charged, the **Battery** indicator on the front panel will light up green.



When the battery level becomes low, the **Battery** indicator on the front panel will light up red.



It is recommended to recharge the battery. When the **Battery** indicator starts blinking red, the battery is almost empty and immediate recharging is required.

An indicator in the software will show the battery status and an estimation of the remaining operating time.

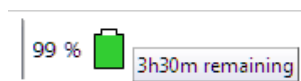

6.1.1 Charging the battery

Charging the battery is done by connecting the external power supply or by connecting the USB. When the battery is charging, the **Battery** indicator on the front panel will light up blue.



When connected to USB or external power, the battery will only be charged when the USB or external power can deliver enough power to operate the instrument and to charge the battery. When not enough power is available, the battery will be discharged. This is indicated by a blue blinking **Battery** indicator on the front panel of the instrument.

6.1.2 Long term storage

When storing the WiFiScope WS5 for a long time, it is recommended to first charge the battery to approximately 70 %. Do not store the WiFiScope WS5 for a long time with an empty battery or 100 % fully charged battery, as this may reduce battery capacity.

6.2 Instrument operation mode

The WiFiScope WS5 has a USB interface and a network interface, used to connect to the instrument via LAN or WiFi. The Power/Mode button at the front panel determines if the WiFiScope WS5 operates as USB instrument or as network (LAN or WiFi) instrument. The light in the Power/Mode button indicates in which mode the WiFiScope WS5 operates. When it is on, the network interface is enabled and the instrument operates as network (LAN or WiFi) instrument. When it is off, the network interface is disabled and the WiFiScope WS5 operates as USB instrument.

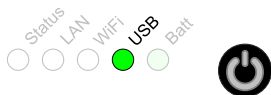

Power/Mode button light off: The WiFiScope WS5 can only be used via USB

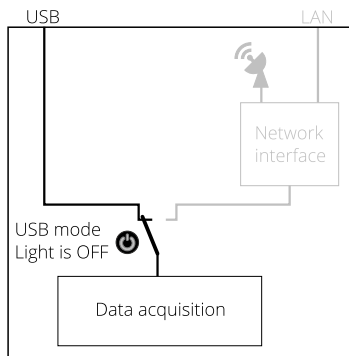

Power/Mode button light on: The WiFiScope WS5 can only be used via LAN or Wifi

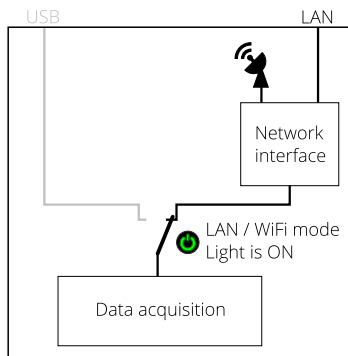

When the network interface of the WiFiScope WS5 is disabled, it will go to a low power state, to save the battery. To enable it again, a short press on the Power/Mode button is required.

When the WiFiScope WS5 is not connected to external power or USB and is not used for two days (network interface disabled), the WiFiScope WS5 switches to "Shipping mode", where the network interface is consuming no power at all. To wake up the WiFiScope WS5 from shipping mode, press the Power/Mode button for 2 seconds. When arriving from the factory, the WiFiScope WS5 will be in shipping mode.

When for some reason the network interface will not disable (the lights remain on), pressing the Power/Mode button for 3 seconds will force the network interface to be disabled.



For network operation, the WiFiScope WS5 uses UDP and TCP/IP **port 5450**. Make sure it is open in your fire wall settings.

6.3 Connect via LAN

To use the WiFiScope WS5 via the LAN, connect the WiFiScope WS5 LAN port on the rear panel to the LAN via a network cable.



The WiFiScope WS5 network interface must be enabled via the Power/Mode button on the front panel of the instrument. While the network interface is initializing, the Power/Mode button will blink, when the initialization is finished, the Power/Mode button will light up continuously.



When the LAN cable is connected, the LAN interface will attempt to get an address via DHCP. When that is successful, the **LAN** indicator on the front panel of the instrument will light up green.

When after 20 seconds no DHCP is found, the network interface will switch to link-local mode and use a link-local address. The **LAN** indicator on the front panel of the instrument will light up blue to indicate link-local mode. Link-local mode remains active until the LAN cable is removed and the LAN LED goes off. When the LAN cable is then reconnected, getting an address via DHCP is attempted again.

In the Multi Channel software, open the Manage instruments dialog and check **Search instruments in local network**.

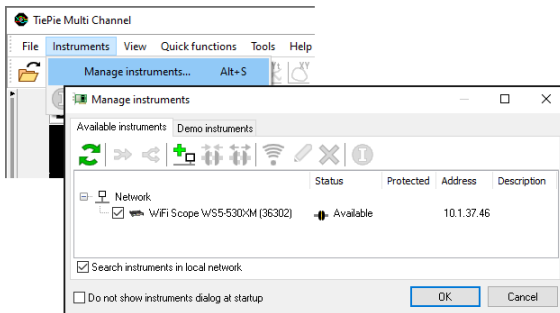

When searching the network is checked, the WiFiScope WS5 will appear. To connect the software to the WiFiScope WS5 check it and close the dialog with the **OK** button.

6.4 Connect via WiFi

There are several different ways to connect the computer to the WiFiScope WS5 via WiFi, depending on whether the computer/laptop has WiFi or not.

6.4.1 The computer/laptop has WiFi

To use the WiFiScope WS5 via Wifi, the network interface must be enabled via the Power/Mode button on the front panel of the instrument. While the network interface is initializing, the Power/Mode button will blink, when the initialization is finished, the Power/Mode button will light continuously.



When the computer does have WiFi, there are two different ways to connect to the instrument via WiFi.

Connect the WiFiScope WS5 to the local WiFi network

1. In the Multi Channel software open the Manage instruments dialog and check **Search instruments in local network**.
2. Place a check in front of the detected WiFiScope WS5. It may take a few seconds to discover the instrument.
3. The software will now ask how to connect to the WiFiScope WS5, select **Add WiFiScope to the 'WiFi' network**.
4. The connection is now set up, if required, the software will ask for the network password. The setup may take up to 30 seconds.

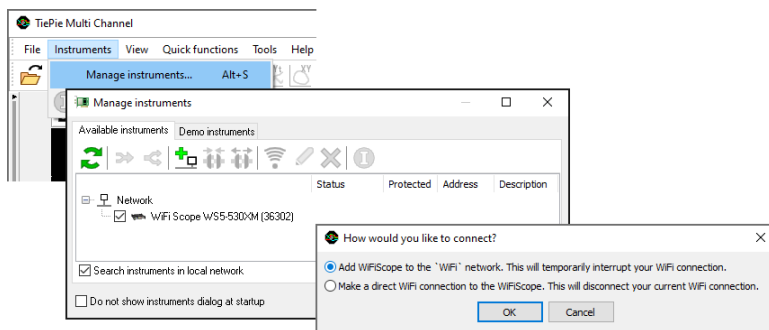

The WiFiScope WS5 is now connected to the local network via WiFi.

Connect to the WiFiScope WS5 directly using WiFi

1. In the Multi Channel software open the Manage instruments dialog and check **Search instruments in local network**.
2. Place a check in front of the detected WiFiScope WS5. It may take a few seconds to discover the instrument.
3. If the computer is currently connected to a WiFi network, the software will ask how to connect to the WiFiScope WS5, select **Add WiFiScope to the 'WiFi' network..**
4. The connection is now set up, if required, the software will ask for the network password. The setup may take up to 30 seconds.

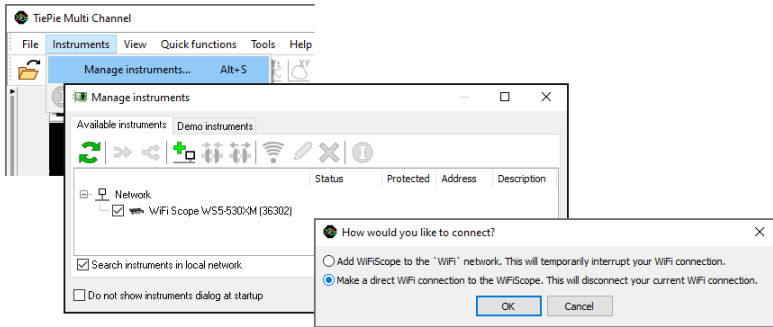

The WiFiScope WS5 is now setup as Access Point, to create its own WiFi network. The computer is disconnected from the local Wifi network and connected to the WiFiScope WS5 WiFi network. The computer will now no longer have internet access and/or access to network locations.

6.4.2 The computer/laptop has NO WiFi

When the computer has no WiFi, the WiFiScope WS5 will have to be connected to the local network. Therefore, the network interface of the WiFiScope WS5 must be enabled via the Power/Mode button on the front panel of the instrument. While the network interface is initializing, the Power/Mode button will blink, when the initialization is finished, the Power/Mode button will light continuously.



1. Connect the WiFiScope WS5 via a cable to the LAN as shown in the section **Connect via LAN**.
2. In the Multi Channel software open the Manage instruments dialog and check **Search instruments in local network**.
3. Place a check in front of the detected WiFiScope WS5. It may take a few seconds to discover the instrument.

4. Click the WiFi button in the instruments manager to open the WiFiScope WS5 web interface.
5. Login to the web interface (default password = **tiepie**).
6. In the web interface, connect to the WiFi network using the **connect** button (and enter its password if required)
7. When successfully connected, close the web interface and disconnect the LAN cable.
8. The Multi Channel software will now detect the WiFiScope WS5 via WiFi, this may take a few seconds.

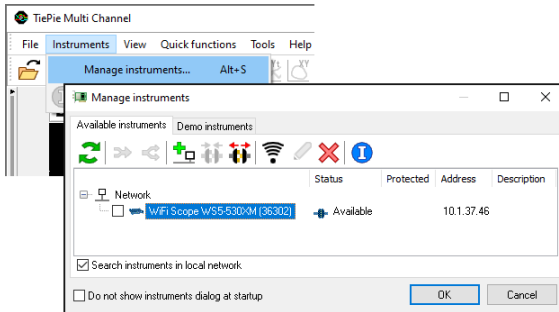

WiFiScope WS5-530XM
(36302)

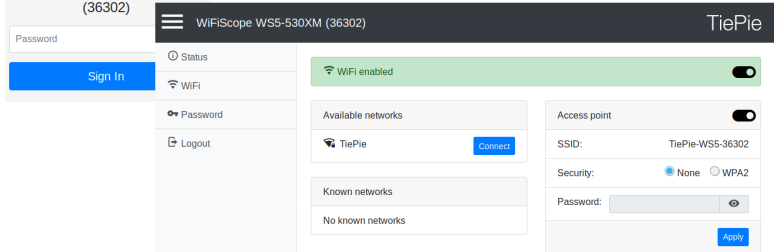

6.5 Connect via USB

To use the WiFiScope WS5 via USB, connect the WiFiScope WS5 USB port on the rear panel to the computer via a USB cable.



When using the instrument via USB, the network interface must be disabled via the Power/Mode button on the front panel of the instrument.

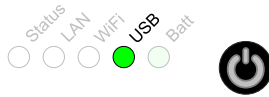

When a USB connection is established, this is indicated by a green lit **USB** indicator on the front panel of the instrument.

The software can now connect to the WiFiScope WS5 as local instrument.

6.5.1 Plug into a different USB port

When the WiFiScope WS5 is plugged into a different USB port, some Windows versions will treat the WiFiScope WS5 as different hardware and will install the drivers again for that port. This is controlled by Microsoft Windows and is not caused by TiePie engineering.

6.6 Operating conditions

The WiFiScope WS5 is ready for use as soon as the software is started. However, to achieve rated accuracy, allow the instrument to settle for 20 minutes. If the instrument has been subjected to extreme temperatures, allow additional time for internal temperatures to stabilize. Because of temperature compensated calibration, the WiFiScope WS5 will settle within specified accuracy regardless of the surrounding temperature.

When more channels are required than one instrument can offer, multiple instruments can be combined into a larger combined instrument. To combine two or more instruments, the instruments need to be connected to each other using special cables.



Combining instruments is only available when the WiFiScope WS5 is connected to the computer via the USB. When used as network instrument (LAN or WiFi), combining is not possible.

The CMI (Combine Multiple Instruments) interface that is available by default on the WiFiScope WS5 provides an easy way to couple multiple oscilloscopes to one combined oscilloscope.

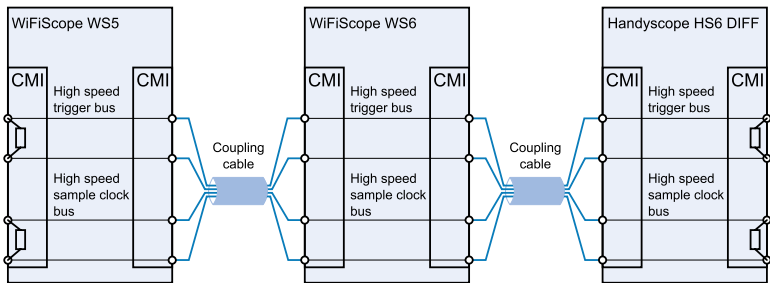

Figure 7.1: CMI diagram

The CMI interface supports automatic recognition of the instrument. The high speed trigger bus is automatically terminated with the correct impedance and the high speed sampling bus is automatically configured and terminated at the beginning and end of the bus. The high speed sampling bus takes care that each Handyscope is fully synchronized to ensure that even at the highest sampling rate the instruments operate at the same sample clock (0 ppm clock error!). The connection order when combining multiple instruments is not important. The CMI interface has built-in intelligence to detect the connections and terminate all buses properly at both ends of the bus. So instruments can be connected to each other in random order. Placing terminators and determining the proper connection order is not required!

Advantages of the CMI (Combine Multiple Instruments) interface are:

- automatic instrument recognition,
- automatic creation and termination of the high speed trigger bus,
- automatic creation and termination of the high speed sampling bus,
- automatic master/slave setting of the sampling clock bus.

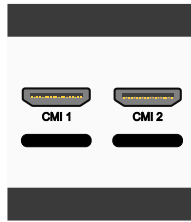

Figure 7.2: CMI connectors

Connecting is done by daisy chaining the CMI connectors of the instruments prior to starting the software, using special coupling cables (order number TP-C50H). The software will detect how the instruments are connected to each other and will automatically terminate the connection bus. The software will combine the connected instruments to one large instrument. The combined instruments will sample using the same clock, with a deviation of 0 ppm.



Figure 7.3: Multiple WiFiScope WS5s combined

A six channel instrument is easily made by connecting three WiFiScope WS5s to each other.

When combining one or more WiFiScope WS5s with other instruments including Handyscope HS6 DIFFs and/or WiFiScope WS6s and/or WiFiScope WS6 DIFFs and/or Automotive Test Scope ATS610004D-XMSGs and/or Automotive Test Scope ATS605004D-XMSs and/or Automotive Test Scope ATS610004DW-XMSGs and/or Automotive Test Scope ATS605004DW-XMSs, the daisy chained CMI bus must begin or end with a Handyscope HS6, Handyscope HS6 DIFF, WiFiScope WS6, WiFiScope WS6 DIFF, Automotive Test Scope ATS610004D-XMSG, Automotive Test Scope ATS605004D-XMS, Automotive Test Scope ATS610004DW-XMSG or Auto-

motive Test Scope ATS605004DW-XMS. Additionally, the maximum sampling rate is limited to 100 MSa/s at 14 bit resolution.

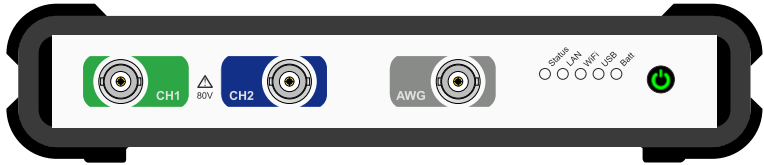

Figure 8.1: Front panel

8.1 CH1 and CH2 input connectors

The CH1 and CH2 BNC connectors are the main inputs of the acquisition system. The outside of the BNC connectors is connected to the ground of the WiFiScope WS5. Connecting the outside of the BNC connector to a potential other than ground will result in a short circuit that may damage the device under test, the WiFiScope WS5 and the computer.

8.2 AWG output connector

The AWG BNC connector is the output of the internal Arbitrary Waveform Generator. The outside of this BNC connector is connected to the ground of the WiFiScope WS5.

When the generator is switched **off** in the software, the generator output is switched to a high impedance, floating state, the output voltage is then undefined.

When the generator is switched **on** in the software and set to **pause**, the generator output is switched to a low impedance ($50\ \Omega$), the output voltage is at the selected offset level.

8.3 Power/Mode button

The **Power/Mode** button is situated at the right of the front of the instrument. It is used to switch the mode of the WiFiScope WS5 between USB use and LAN or WiFi use. To use the WiFiScope WS5 via LAN or WiFi, the network interface must be enabled, by pressing the Power/Mode button. During initializing the network interface, the Power/Mode button will blink green. When initialization is finished, the indicator in the button will be lit continuously green.

When using the WiFiScope WS5 via USB, the network interface must be disabled, by pressing the Power/Mode button again. The light in the button will go off.

8.4 Status indicators

The WiFiScope WS5 has a number of status indicators, which can be lit to indicate the status of the instrument.

8.4.1 Status

The status light indicates whether the WiFiScope WS5 is being used by software or is not in use.

- When lit continuously green, the WiFiScope WS5 is not being used, it is available to be opened in software.
- When lit continuously blue, the WiFiScope WS5 is in use, it is already opened in software.

8.4.2 LAN

When the **LAN** indicator is lit, the WiFiScope WS5 is connected to a wired network.

- When lit continuously green, the WiFiScope WS5 has received a network address via DHCP.
- When lit continuously blue, the WiFiScope WS5 is assigned a link local address.

8.4.3 WiFi

When the **WiFi** indicator is lit, the WiFiScope WS5 is connected to the computer and measuring via a WiFi network. The color indicates how the instrument operates:

- When blinking green, the WiFiScope WS5 is trying to establish a WiFi connection to an existing network.
- When lit continuously green, the WiFiScope WS5 has established a connection to an existing WiFi network and has received a network address via DHCP.
- When lit continuously blue, the WiFiScope WS5 acts as WiFi access point. Connect the computer via WiFi to the network that the WiFiScope WS5 creates.

8.4.4 USB

When the **USB** indicator is green, the WiFiScope WS5 is connected to the computer and measuring via USB.

8.4.5 Batt

The **Batt** indicator can indicate various different states:

- When lit continuously green, the battery is full, while the external power is still connected. When external power is not connected, the battery is being discharged, its level is higher than 5
- When lit continuously blue, the battery is charging.
- When blinking blue, external power or USB power is connected, but cannot deliver enough power to charge the battery.
- When lit continuously red, the battery level is below 5 %, charging is recommended.
- When blinking red, the battery level is below 2 %, immediate charging is required.

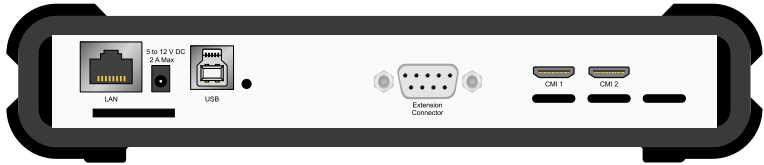

Figure 9.1: Rear panel

9.1 Power

The WiFiScope WS5 can be powered by its internal battery, via a dedicated power input at the rear panel and via the USB interface.

To charge the battery, connect the external power supply. The battery can also be charged via the USB, but only if the USB can deliver enough power to operate the instrument and charge the battery. If not enough power for both is available, the battery will not be charged, but will be used by the instrument and be discharged.

The specifications of the dedicated power connector are:



Pin	Dimension	Description
Center pin	Ø1.3 mm	positive
Outside bushing	Ø3.5 mm	ground

Figure 9.2: Power connector

The following minimum and maximum voltages apply to the power inputs:

Minimum	5 V _{DC} / 2 A
Maximum	15 V _{DC} / 2 A

Table 9.1: Maximum voltages

9.1.1 Power adapter

The WiFiScope WS5 comes with an external 12 V_{DC} 2 A power adapter that can be connected to any mains power net that supplies 100 – 240 V_{AC}, 50 – 60 Hz. The external power adapter can be connected to the dedicated power connector.



Figure 9.3: Power adapter

9.2 USB

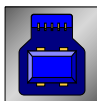

USB

Figure 9.4: USB connector

The WiFiScope WS5 is equipped with a USB 2.0 High speed (480 Mbit/s) interface with a USB 3 type B SuperSpeed socket.

9.3 LAN

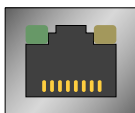

LAN

Figure 9.5: LAN connector

The WiFiScope WS5 is equipped with a 1 Gbit LAN interface with RJ45 socket.

9.4 Extension Connector



Figure 9.6: Extension connector

A 9 pin female D-sub connector is available at the back of the WiFiScope WS5 containing the following signals:

Pin	Description	Pin	Description	Pin	Description
1	EXT 1 (LVTTTL)	4	reserved	7	NC
2	EXT 2 (LVTTTL)	5	reserved	8	Power OUT (see description)
3	EXT 3 (LVTTTL)	6	GND	9	External Clock in

Table 9.2: Pin description Extension connector

Pins EXT 1, EXT 2 and EXT 3 are equipped with internal 1 kOhm pull-up resistors to 2.5 V. These pins can simultaneously be used as inputs and outputs. Each pin can be configured as external digital trigger input for the acquisition system and/or the generator of the WiFiScope WS5. Also, each pin can be configured to output one of the following function generator outputs:

- Generator start
- Generator stop
- Generator new period

Pin 8, Power OUT, is 5 V_{DC} and can supply 100 mA and is available when the Power/Mode button of the WiFiScope WS5 is switched on.

The External Clock In signal must be a 10 MHz \pm 1% or a 16.369 MHz \pm 1% 2.5 V TTL signal.

9.5 CMI

The WiFiScope WS5 has two Combine Multiple Instruments interface (CMI) connectors at the rear of the instrument. These connectors are used to combine multiple instruments to a single combined instrument to perform synchronized measurements. This requires a TP-C50H coupling cable per two instruments.



Figure 9.7: CMI connector



The CMI connectors use HDMI type C sockets, but are not HDMI compliant. They can not be used to connect an HDMI device to the WiFiScope WS5.

9.6 Factory reset

Right next to the LAN connector a reset button is located to perform a factory reset on the WiFiScope WS5. The factory reset clears all user settings like wifi networks and login codes. To perform a factory reset, perform the following steps:

- If the Power/Mode button on the front is lit, press it to switch it off.
- Press the reset button on the rear and keep it pressed.
- While keeping the reset button pressed, press the Power/Mode button on the front again, its light will start blinking.
- Keep the reset button pressed until the Power/Mode button starts to light continuously, then release the reset button. This may take up to 20 seconds.

The instrument is now back in factory state as when it left the factory. It is ready to be used again in the same way as indicated in chapter 6.2.

9.7 Ventilation slots

Below the LAN connector and power connector a ventilation slot is located, with a fan behind it. And below the CMI connectors three smaller ventilation slots are located.

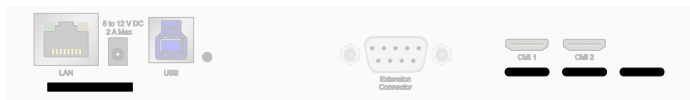

Figure 9.8: Ventilation slots



Do not block the ventilation slots as this may cause the WiFiScope WS5 becoming too hot.

Do not insert objects in the ventilation slot as this may damage the fan.

To achieve rated accuracy, allow the instrument to settle for 20 minutes. When subjected to extreme temperatures, allow extra time for internal temperatures to stabilize. Because of temperature compensated calibration, the WiFiScope WS5 will settle within specified accuracy regardless of the surrounding temperature.

10.1 Acquisition system

Number of input channels	2 analog		
CH1, CH2	BNC		
Type	Single ended		
Resolution	8, 12, 14, 16 bit user selectable		
Accuracy	0.25% of full scale \pm 1 LSB		
Ranges (full scale)	\pm 200 mV \pm 2 V \pm 20 V	\pm 400 mV \pm 4 V \pm 40 V	\pm 800 mV \pm 8 V \pm 80 V
Coupling	AC/DC		
Impedance	1 M Ω / 25 pF \pm 1 %		
Maximum voltage	200 V (DC + AC peak <10 kHz)		
Bandwidth	Ch1	Ch2	
-3 dB, at 75 % of full scale input	250 MHz	100 MHz	
AC coupling cut off freq. (-3dB)	\pm 1.5 Hz		
SureConnect	Optionally available (option S)		
Maximum voltage on connection	200 V (DC + AC peak <10 kHz)		
Resistance measurement	Optionally available (option S)		
Ranges (Full scale)	100 Ω 1 k Ω 10 k Ω 100 k Ω 1 M Ω	200 Ω 2 k Ω 20 k Ω 200 k Ω 2 M Ω	500 Ω 5 k Ω 50k Ω 500 k Ω
Accuracy	1%		
Response time (to 95%)	<10 μ s		
Maximum sampling rate	WS5-540	WS5-530	WS5-220
8 bit, 12 bit			
Measuring 1 channel	500 MSa/s	500 MSa/s	200 MSa/s
Measuring 2 channels	200 MSa/s	200 MSa/s	100 MSa/s
14 bit	100 MSa/s	100 MSa/s	50 MSa/s
16 bit	6.25 MSa/s	6.25 MSa/s	3.125 MSa/s
Maximum streaming rate ^{1,2}	WS5-540	WS5-530	WS5-220
8 bit			
Measuring 1 channel	40 MSa/s	40 MSa/s	20 MSa/s
Measuring 2 channels	20 MSa/s	20 MSa/s	10 MSa/s
12 bit, 14 bit			
Measuring 1 channel	20 MSa/s	20 MSa/s	10 MSa/s
Measuring 2 channels	10 MSa/s	10 MSa/s	5 MSa/s
16 bit	6.25 MSa/s	6.25 MSa/s	3.125 MSa/s

¹ On some computers, the highest streaming rates may not be available, due to computer restrictions.

² When connected through LAN or WiFi, the maximum streaming rates are limited and depend on the speed and load of the network

10.2 Acquisition system - continued

Memory per channel	Standard model	XM Option
Measuring 1 channel	128 KiSamples	64 MSamples
Measuring 2 channels	128 KiSamples	32 MSamples
Sampling source		
Internal	TCXO	
Accuracy	±0.0001%	
Stability	±1 ppm over 0 °C to +55 °C	
Time base aging	±1 ppm per year time base aging	
External	LV-TTL (2.5 V), on Extension connector	
Input frequency	10 MHz ±1 %	

10.3 Trigger system

System	Digital, 2 levels
Source	CH1, CH2, digital external, OR, generator start, generator new period, generator stop
Trigger modes	Rising edge, falling edge, any edge, inside window, outside window, enter window, exit window, pulse width
Level adjustment	0 to 100% of full scale
Hysteresis adjustment	0 to 100% of full scale
Resolution	0.024 % (12 bits)/0.006 % (14/16 bits)
Pre trigger	0 to selected record length, 1 sample resolution
Post trigger	0 to selected record length, 1 sample resolution
Trigger hold-off	0 to 64 MSamples, 1 sample resolution
Trigger delay	0 to 16 GSamples, 1 sample resolution
Segmented trigger	Available via LibTiePie SDK
Maximum number of segments	1024
Minimum segment length	1 sample
Maximum segment length	64 M / number of segments measuring 1 channel 32 M / number of segments measuring 2 channels
Trigger rearm time	Sample frequency dependent, < 700 ns on highest sampling rate
Digital external trigger	
Input	Extension connector pins 1, 2 and 3
Range	0 to 2.5 V (TTL)
Coupling	DC
Jitter	Depending on source and sampling rate
Source = channel	≤ 1 sample
Source = external or generator	
Sampling rate = 500 MSa/s	≤ 8 samples
Sampling rate < 500 MSa/s	≤ 4 samples
Sampling rate ≤ 100 MSa/s	≤ 1 sample

10.4 Arbitrary Waveform Generator

Output channel	1 analog, BNC		
DAC resolution	14 bit @ 240 MSa/s		
Output range	at open circuit		
frequency \leq 10 MHz	-12 V to 12 V (24 V _{pp})		
frequency \leq 20 MHz	-11 V to 11 V (22 V _{pp})		
frequency \leq 30 MHz	-9 V to 9 V (18 V _{pp})		
frequency \leq 40 MHz	-7.5 V to 7.5 V (15 V _{pp})		
Amplitude			
Range (open circuit)	0.12 V (0.24 V _{pp}) 1.2 V (2.4 V _{pp}) 12 V (0.24 V _{pp})		
Resolution	12 bit		
Accuracy	0.4% of range		
DC offset			
Range	-12 V to +12 V (open circuit)		
Resolution	12 bit		
Accuracy	0.4% of range		
Noise level			
0.12 V	900 μ V _{RMS}		
1.2 V	1.3 mV _{RMS}		
12 V	1.5 mV _{RMS}		
Coupling	DC		
Impedance	50 Ω		
Overload protection	Output turns off when overload is applied. Instrument will tolerate a short circuit to ground indefinitely.		
System	Constant Data Size		
Memory			
Standard model	256 KiSamples		
XM option	64 MiSamples		
Operating modes	Continuous, triggered, gated		
Maximum sampling rate	WS5-540	WS5-530	WS5-220
	240 MSa/s	240 MSa/s	200 MSa/s
Sampling source	Internal TCXO		
Accuracy	0.0001 %		
Stability	\pm 1 ppm over 0 °C to +55 °C		
Time base aging	\pm 1 ppm per year		
Waveforms			
Standard	Sine, square, triangle, pulse, noise, DC		
Burst			
Waveforms	Sine, square, triangle, noise, arbitrary		
Count	1 to 65535		
Trigger	Software, external		
Sweep	Available only on models with extended memory option XM		
Waveforms	Sine, square, triangle, noise, arbitrary		
Type	Linear, logarithmic		
Count	Up, down		
Trigger	Software, external		

Arbitrary Waveform Generator - continued

Signal characteristics			
Sine	W55-540	W55-530	W55-220
Frequency range: 1 μ Hz to	40 MHz	30 MHz	20 MHz
Amplitude flatness	Relative to 1 kHz		
<100 kHz	± 0.1 dB		
<5 MHz	± 0.15 dB		
<20 MHz	± 0.3 dB (Amplitude ≤ 11 V (22 V_{pp}))		
<30 MHz	± 0.4 dB (Amplitude ≤ 9 V (18 V_{pp}))		
<40 MHz	± 1 dB (Amplitude ≤ 7.5 V (15 V_{pp}))		
Spurious			
<100 kHz	-75 dB _c		
100 kHz to 1 MHz	-70 dB _c		
1 MHz to 10 MHz	-60 dB _c		
10 MHz to 15 MHz	-55 dB _c		
15 MHz to 20 MHz	-45 dB _c		
20 MHz to 30 MHz	-35 dB _c		
30 MHz to 40 MHz	-30 dB _c		
Square	W55-540	W55-530	W55-220
Frequency range: 1 μ Hz to	40 MHz ²	30 MHz	20 MHz
Rise/fall time	<8 ns		
Overshoot	<1%		
Variable duty cycle	0.01 % to 99.99 %		
Asymmetry	<0 % of period + 5 ns (@ 50% duty cycle)		
Jitter (RMS)	<50 ps		
Triangle	W55-540	W55-530	W55-220
Frequency range: 1 μ Hz to	40 MHz ²	30 MHz	20 MHz
Nonlinearity (of peak output)	<0.01 %		
Symmetry	0 % to 100 %, 0.1% steps		
Pulse			
Period	100 ns to 1 Ms		
Pulse width	1 digit to period-1 digit (min. 20 ns and period-20 ns)		
Step size	6 digits, minimum of 1 ns		
Overshoot	<1 %		
Jitter (RMS)	<50 ps		
Noise			
Bandwidth (typical)	30 MHz		
Arbitrary	W55-540	W55-530	W55-220
Frequency range: 1 μ Hz to	30 MHz	30 MHz	20 MHz
Maximum sampling rate	240 MSa/s	240 MSa/s	200 MSa/s
Pattern length	1 to 64 MiSamples		
Rise/fall time	<8 ns		
Nonlinearity (of peak output)	<0.01 %		
Settling time	<8 ns to 10 % final value		
Jitter (RMS)	<50 ps		

² Above 30 MHz not specified

10.5 Power

Power	From USB, external input or built-in battery
Consumption	12 V _{DC} , 2 A max
Internal battery	Li-ion
Capacity	7000 mAh, 3.7 V
Operating time	Strongly depending on instrument setup, ≥ 3 hours
Power adapter	External
Input	110 to 240 V _{AC} , 50 to 60 Hz, 500 mA
Output	12 V _{DC} , 2 A
Dimension	
Height	57 mm / 2.2"
Width	30 mm / 1.2"
Length	88 mm / 3.4"
Cable length	1.8 m / 70"
Order number	TP-UES24LCP-120200SPA
Replaceable mains plugs for	EU, US, AU, UK

10.6 Multi-instrument synchronization

Combining instruments is only available when all instruments are connected via USB. When instruments are connected via LAN or WiFi, combining is not available.

Maximum number of instruments	Limited by available number of USB ports
Synchronization accuracy	0 ppm
CMI interface	2x, CMI 1, CMI 2
Required coupling cable	TP-C50H Coupling cable CMI
Maximum coupling cable length	50 cm

10.7 Physical

Height	44 mm / 1.7"
Length	187 mm / 7.4"
Width	215 mm / 8.5"
Weight	751 g / 26.5 ounce
USB cord length	1.5 m / 59"

10.8 I/O connectors

CH1, CH2	BNC
AWG	BNC
USB	USB3 type B Super Speed socket
LAN	RJ45 socket
Extension connector	D-sub 9 pins female
Power	3.5 mm power socket
CMI connectors 1–2	HDMI type C socket

10.9 Interface

USB	USB 2.0 HighSpeed (480 Mbit/s) (USB 3.0 compatible)
Network	
LAN	1 Gbps
WiFi	802.11
Network port (TCP/IP and UDP)	5450 (IANA assigned)

10.10 System requirements

PC I/O connection	USB 2.0 or newer
Operating System	Windows 10, 32 and 64 bits

10.11 Environmental conditions

Operating	
Ambient temperature	10 °C to 35 °C for rated accuracy 10 °C to 40 °C without specifications
Relative humidity	10 to 90% non condensing
Charging	
Ambient temperature	0 °C to 35 °C
Relative humidity	10 to 90% non condensing
Storage	
Ambient temperature	0 °C to 35 °C
Relative humidity	5 to 95% non condensing

10.12 Certifications and Compliances

CE mark compliance	Yes
RoHS	Yes
EN 55011:2016/A1:2017	Yes
EN 55022:2011/C1:2011	Yes
IEC 61000-6-1:2019 EN	Yes
IEC 61000-6-3:2007/A1:2011/C11:2012	Yes
ICES-001:2004	Yes
AS/NZS CISPR 11:2011	Yes
IEC 61010-1:2010/A1:2019	Yes
UL 61010-1, Edition 3	Yes

10.13 Probes

Model	HP-9250	
	X1	X10
Bandwidth	6 MHz	250 MHz
Rise time	58 ns	1.4 ns
Input impedance	1 M Ω oscilloscope impedance	10 M Ω incl. 1 M Ω oscilloscope impedance
Input capacitance	47 pF + oscilloscope capacitance	17 pF
Compensation range	-	10 to 35 pF
Working voltage (DC + AC peak)	300 V 150 V CAT II	600 V 300 V CAT II

10.14 Package contents

Instrument	WiFiScope WS5
Probes	2 x X1 / X10 switchable, HP-9250
Accessories	External power adapter USB cable network cable
Software	Windows 10, 32 and 64 bits, via website
Drivers	Windows 10, 32 and 64 bits, via website
Software Development Kit	Windows 10 and Linux, via website
Manual	Quick Start Guide, Instrument manual and software manual

10.15 Warranty

TiePie engineering instruments are designed, manufactured and tested to provide high reliability. In the unlikely event you experience difficulties, the TiePie engineering instruments are fully warranted for two years.	
This warranty includes	All parts and labor (excluding probes and/or measure leads and/or batteries) Warranty on batteries is 6 months. No charge for return shipping Long-term 7 year support Upgrade to the latest software at no charge
Optionally available	Extension to five year warranty, option W5

If you have any suggestions and/or remarks regarding this manual, please contact:

TiePie engineering
Koperslagersstraat 37
8601 WL SNEEK
The Netherlands

Tel.: +31 515 415 416
Fax: +31 515 418 819
E-mail: support@tiepie.nl
Site: www.tiepie.com



