

WiFiScope WS6 DIFF

User manual

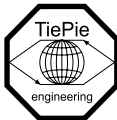

USB
Network
WiFi
Battery power



TiePie engineering

ATTENTION!

Measuring directly on the **line voltage** can be very dangerous.

Copyright ©2025 TiePie engineering.
All rights reserved.

Revision 2.52, March 2025

This information is subject to change without notice.
Despite the care taken for the compilation of this user manual,
TiePie engineering can not be held responsible for any damage
resulting from errors that may appear in this manual.

Contents

| | | |
|----------|------------------------------------|-----------|
| 1 | Welcome | 1 |
| 2 | Safety | 3 |
| 3 | Declaration of conformity | 5 |
| 4 | Introduction | 9 |
| 4.1 | Differential input | 11 |
| 4.1.1 | SafeGround on each channel | 13 |
| 4.1.2 | Differential attenuators | 14 |
| 4.1.3 | Differential test lead | 15 |
| 4.2 | Sampling | 16 |
| 4.3 | Sampling rate | 16 |
| 4.3.1 | Aliasing | 17 |
| 4.4 | Digitizing | 18 |
| 4.5 | Signal coupling | 19 |
| 4.6 | Probe compensation | 19 |
| 5 | Driver installation | 21 |
| 5.1 | Introduction | 21 |
| 5.1.1 | Where to find the driver setup | 21 |
| 5.1.2 | Executing the installation utility | 21 |
| 6 | Hardware installation | 25 |
| 6.1 | Power the instrument | 25 |
| 6.1.1 | Charging the battery | 26 |
| 6.1.2 | Long term storage | 26 |
| 6.2 | Instrument operation mode | 27 |
| 6.3 | Connect via LAN | 28 |
| 6.4 | Connect via WiFi | 29 |
| 6.4.1 | The computer/laptop has WiFi | 29 |
| 6.4.2 | The computer/laptop has NO WiFi | 30 |
| 6.5 | Connect via USB | 32 |

| | | |
|-----------|--|-----------|
| 6.5.1 | Plug into a different USB port | 32 |
| 6.6 | Operating conditions | 32 |
| 7 | Instrument ground compensation | 33 |
| 7.1 | Ground compensation cable | 33 |
| 7.2 | When using the the ground compensation cable | 33 |
| 7.3 | When is the ground compensation not required | 34 |
| 7.4 | Why ground compensation? | 34 |
| 8 | Combining and synchronizing instruments | 35 |
| 8.1 | Limitation | 36 |
| 9 | Front panel | 37 |
| 9.1 | Channel input connectors | 37 |
| 9.2 | EMI probe grounding | 37 |
| 9.3 | Power/Mode button | 37 |
| 9.4 | Status indicators | 37 |
| 9.4.1 | Status | 38 |
| 9.4.2 | LAN | 38 |
| 9.4.3 | WiFi | 38 |
| 9.4.4 | USB | 38 |
| 9.4.5 | Batt | 38 |
| 10 | Rear panel | 39 |
| 10.1 | Power | 39 |
| 10.1.1 | Power adapter | 39 |
| 10.2 | USB | 40 |
| 10.3 | LAN | 40 |
| 10.4 | Factory reset | 40 |
| 10.5 | Extension Connector | 41 |
| 10.6 | Ground connector | 41 |
| 10.7 | CMI | 42 |
| 10.8 | Ventilation slots | 42 |
| 11 | Firmware update | 43 |
| 11.1 | Preparation | 43 |

| | | |
|-----------|---|-----------|
| 11.2 | Switching to firmware update mode | 43 |
| 11.3 | Updating the firmware | 44 |
| 12 | Web interface | 45 |
| 12.1 | Enter the web interface | 45 |
| 12.2 | Setting a fixed IP address | 46 |
| 13 | Specifications | 47 |
| 13.1 | Definition of accuracy | 47 |
| 13.2 | Acquisition system | 47 |
| 13.3 | Trigger system | 49 |
| 13.4 | Probe calibration | 49 |
| 13.5 | Power | 50 |
| 13.6 | Physical | 50 |
| 13.7 | Multi-instrument synchronization | 50 |
| 13.8 | I/O connectors | 51 |
| 13.9 | Interface | 51 |
| 13.10 | System requirements | 51 |
| 13.11 | Environmental conditions | 51 |
| 13.12 | Certifications and Compliances | 51 |
| 13.13 | Measure leads | 52 |
| 13.14 | Differential attenuators | 52 |
| 13.15 | Package contents | 53 |
| 13.16 | Warranty | 53 |



Wireless measuring has now become a reality with the WiFiScope WS6 DIFF. If a large distance needs to be bridged between the measuring instrument and the PC, the WiFiScope WS6 DIFF is the solution for this. Fast measurements and high speed data acquisition are now possible wherever the WiFiScope WS6 DIFF is located in the world.

- Because the WiFiScope WS6 DIFF is battery-powered, it can be used stand-alone for a long time.
- For measurements in hazardous situations or places where it is not accessible to people for long, the WiFiScope WS6 DIFF offers the solution.
- A connection via WiFi or Network (LAN or WAN with possibly POE) gives the user the possibility to place the measuring instrument where this was previously not possible.
- Collecting and viewing measurement data from different locations on a PC / Laptop is now a possibility because the software supports more WiFiScopes at the same time.
- With the very extensive software package, most measurements can be performed.
- A large library of presets is available so that a novice user can immediately perform advanced measurements with a few mouse clicks.
- The WiFiScope WS6 DIFF has 4 input channels with a maximum sampling rate of 1 GSa/s and a bandwidth of 250 MHz.
- With a WiFi connection, the WiFiScope WS6 DIFF is no longer directly connected to the PC or laptop and short circuits are excluded, this eliminates the fear that something will happen to the PC or Laptop.
- A big advantage of the WiFiScopes is that no ground loops can occur. In traditional measurement systems, ground loops give many problems, resulting in unreliable measurement results. With the WiFiScope, because of the absence of ground loops, long distance remote measurements are possible without the results being influenced by ground loops. Also on short distances the absence of ground loops is important for performing reliable measurements. The WiFiScope prevents ground loops from forming so that the measurement speed and resolution are not affected and the measurements remain reliable.
- Integrating the WiFiScope WS6 DIFF in your own software environment is supported by an API with examples so that the WiFiScope WS6 DIFF can be widely used
- Thanks to a very good hardware structure and advanced software drivers, the WiFiScope WS6 DIFF is suitable for high speed data acquisition up to speeds of 5 MSa/s and measurements up to 1 GSa/s with a record length of 256 MSamples of memory per channel with a resolution of 12 to 16 bit.

When working with electricity, no instrument can guarantee complete safety. It is the responsibility of the person who works with the instrument to operate it in a safe way. Maximum security is achieved by selecting the proper instruments and following safe working procedures. Safe working tips are given below:

- Always work according (local) regulations.
- Work on installations with voltages higher than $25 V_{AC}$ or $60 V_{DC}$ should only be performed by qualified personnel.
- Avoid working alone.
- Observe all indications on the WiFiScope WS6 DIFF before connecting any wiring
- Check the probes/test leads for damages. Do **not** use them if they are damaged
- Take care when measuring at voltages higher than $25 V_{AC}$ or $60 V_{DC}$.
- Do not operate the equipment in an explosive atmosphere or in the presence of flammable gases or fumes.
- Do not use the equipment if it does not operate properly. Have the equipment inspected by qualified service personal. If necessary, return the equipment to TiePie engineering for service and repair to ensure that safety features are maintained.

Declaration of conformity

3

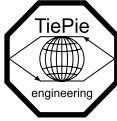

TiePie engineering
Koperslagersstraat 37
8601 WL Sneek
The Netherlands

EC Declaration of conformity

We declare, on our own responsibility, that the product

WiFiScope WS6 DIFF-1000(XM/E/S/G)
WiFiScope WS6 DIFF-500(XM/S/G)
WiFiScope WS6 DIFF-200(XM/S/G)

for which this declaration is valid, is in compliance with

EC directive 2011/65/EU (the RoHS directive)
including up to amendment 2021/1980,

EC regulation 1907/2006 (REACH)
including up to amendment 2021/2045,

and with

EN 55011:2016/A1:2017
EN 55022:2011/C1:2011

IEC 61000-6-1:2019 EN
IEC 61000-6-3:2007/A1:2011/C11:2012 EN

according the conditions of the EMC standard 2004/108/EC,

also with

Canada: ICES-001:2004

Australia/New Zealand: AS/NZS CISPR 11:2011

and

IEC 61010-1:2010/A1:2019

USA: UL 61010-1, Edition 3

and is categorized as $30 V_{RMS}$, $42 V_{pk}$, $60 V_{DC}$

Sneek, 1-9-2022
ir. A.P.W.M. Poelsma

A handwritten signature in blue ink, appearing to read "Poelsma", written over a blue horizontal line.

WiFi module

The WiFiScope WS6 DIFF contains the PIXI-9377 WiFi module.

FCC reports for this module can be found at [fcc.report/FCC-ID/2AKZA-QCA9377](https://www.fcc.gov/reports/2018/02/20180201-2AKZA-QCA9377)

FCC statement

FCC 15.119

This device complies with Part 15 of FCC Rules. Operation is Subject to following two conditions:

1. This device may not cause harmful interference, and
2. This device must accept any interference received including interference that cause undesired operation.

FCC 15.105

This equipment has been tested and found to comply within the limits for a Class B digital device, pursuant to part 15 of the FCC Rules. These limits are designed to provide reasonable protection against harmful interference in a residential installation. This equipment generates, uses, and can radiate radio frequency energy and, if not installed and used in accordance with the instructions, may cause harmful interference to radio communications. However, there is no guarantee that interference will not occur in a particular installation. If this equipment does cause harmful interference to radio or television reception, which can be determined by turning the equipment off and on, the user is encouraged to try to correct the interference by one or more of the following measures:

- Reorient or relocate the receiving antenna
- Increase the separation between the equipment and receiver
- Connect the equipment into an outlet on a different circuit from that to which the receiver is connected.
- Consult the dealer or an experienced radio/TV technician for help.

Any changes or modifications not expressly approved by TiePie engineering can void the authority to operate equipment.

This equipment complies with FCC radiation exposure limits set forth for an uncontrolled environment. This equipment should be installed and operated with minimum distance of 20 cm between the radiator and your body

Environmental considerations

This section provides information about the environmental impact of the WiFiScope WS6 DIFF.

End-of-life handling

Production of the WiFiScope WS6 DIFF required the extraction and use of natural resources. The equipment may contain substances that could be harmful to the environment or human health if improperly handled at the WiFiScope WS6 DIFF's end of life.



In order to avoid release of such substances into the environment and to reduce the use of natural resources, recycle the WiFiScope WS6 DIFF in an appropriate system that will ensure that most of the materials are reused or recycled appropriately.

The shown symbol indicates that the WiFiScope WS6 DIFF complies with the European Union's requirements according to Directive 2002/96/EC on waste electrical and electronic equipment (WEEE).



Before using the WiFiScope WS6 DIFF first read chapter 2 about safety.

Many technicians investigate electrical signals. Though the measurement may not be electrical, the physical variable is often converted to an electrical signal, with a special transducer. Common transducers are accelerometers, pressure probes, current clamps and temperature probes. The advantages of converting the physical parameters to electrical signals are large, since many instruments for examining electrical signals are available.

The WiFiScope WS6 DIFF is a portable four channel measuring instrument with differential inputs. It can be connected to the computer via USB, wired ethernet and WiFi. When used via WiFi, the WiFiScope WS6 DIFF can be connected to an existing WiFi network or can act as access point to create its own WiFi network.

The WiFiScope WS6 DIFF is equipped with a built-in battery for wireless operation, but can also be powered by an external power supply (included in the package) or via the USB interface.

It is available in several models with different maximum sampling rates. The native resolutions are 8, 12 and 14 bits and a user selectable resolution of 16 bits is available too, with adjusted maximum sampling rates:

| Measuring | | Model | | |
|------------|-----------|------------|-------------|------------|
| Resolution | Channels | WS6-1000 | WS6-500 | WS6-200 |
| 8 bit | 1 ch | 1 GSa/s | 500 MSa/s | 200 MSa/s |
| | 2 ch | 500 MSa/s | 200 MSa/s | 100 MSa/s |
| | 3 or 4 ch | 200 MSa/s | 100 MSa/s | 50 MSa/s |
| 12 bit | 1 ch | 500 MSa/s | 200 MSa/s | 100 MSa/s |
| | 2 ch | 200 MSa/s | 100 MSa/s | 50 MSa/s |
| | 3 or 4 ch | 100 MSa/s | 50 MSa/s | 20 MSa/s |
| 14 bit | 1 to 4 ch | 100 MSa/s | 50 MSa/s | 20 MSa/s |
| 16 bit | 1 to 4 ch | 6.25 MSa/s | 3.125 MSa/s | 1.25 MSa/s |

Table 4.1: Maximum sampling rates

The WiFiScope WS6 DIFF supports high speed continuous streaming measurements. The maximum streaming rates when connected to a USB 3.0 port are:

| Measuring | | Model | | |
|------------|-----------|-------------------------|-------------------------|------------|
| Resolution | Channels | WS6-1000 | WS6-500 | WS6-200 |
| 8 bit | 1 ch | 200 MSa/s ¹ | 100 MSa/s ¹ | 40 MSa/s |
| | 2 ch | 100 MSa/s ² | 50 MSa/s ² | 20 MSa/s |
| | 3 or 4 ch | 50 MSa/s ³ | 25 MSa/s ³ | 10 MSa/s |
| 12 bit | 1 ch | 100 MSa/s ² | 50 MSa/s ² | 20 MSa/s |
| | 2 ch | 50 MSa/s ³ | 25 MSa/s ³ | 10 MSa/s |
| | 3 or 4 ch | 25 MSa/s ⁴ | 12.5 MSa/s ⁴ | 5 MSa/s |
| 14 bit | 1 ch | 100 MSa/s ² | 50 MSa/s ² | 20 MSa/s |
| | 2 ch | 50 MSa/s ³ | 25 MSa/s ³ | 10 MSa/s |
| | 3 or 4 ch | 25 MSa/s ⁴ | 12.5 MSa/s ⁴ | 5 MSa/s |
| 16 bit | 1 to 4 ch | 6.25 MSa/s ⁵ | 3.125 MSa/s | 1.25 MSa/s |

Table 4.2: Maximum streaming rates

¹ ≤ 40 MSa/s when connected to USB 2.0

² ≤ 20 MSa/s when connected to USB 2.0

³ ≤ 10 MSa/s when connected to USB 2.0

⁴ ≤ 5 MSa/s when connected to USB 2.0

⁵ ≤ 3.125 MSa/s when connected to USB 2.0, measuring 3 or 4 channels

These maximum streaming rates are only achieved when using the WiFiScope WS6 DIFF via its USB interface. When used as wired network instrument, maximum streaming rates may be lower, depending on network speed and load. When used via WiFi, maximum streaming rates will be lower and will depend on WiFi signal strength, distance to access point and network load.

The WiFiScope WS6 DIFF is available with two memory configurations, these are:

| Measuring | | Model | | |
|----------------|-----------|----------|----------------|-------------|
| Resolution | Channels | Standard | with XM option | |
| | | | via USB | via network |
| 8 bit | 1 ch | 1 MSa | 256 MSa | 64 MSa |
| | 2 ch | 512 KSa | 128 MSa | 32 MSa |
| | 3 or 4 ch | 256 KSa | 64 MSa | 16 MSa |
| 12, 14, 16 bit | 1 ch | 512 KSa | 128 MSa | 32 MSa |
| | 2 ch | 256 KSa | 64 MSa | 16 MSa |
| | 3 or 4 ch | 128 KSa | 32 MSa | 8 MSa |

Table 4.3: Maximum record lengths per channel

When used as a (WiFi) network instrument, maximum record lengths are limited.

Optionally available for the WiFiScope WS6 DIFF is **SureConnect** connection test. **SureConnect** connection test tells you immediately whether your test probe or clip actually makes electrical contact or not. No more doubt whether your probe doesn't make contact or there really is no signal. This is useful when surfaces are oxidized and your probe cannot get a good electrical contact. Simply activate the **SureConnect** and you know whether there is contact or not. Also when back probing connectors in confined places, **SureConnect** immediately shows whether the probes make contact or not.



Models of the WiFiScope WS6 DIFF with **SureConnect** come with resistance measurement on all channels. Resistances up to 2 MOhm can be measured directly. Resistance can be shown in meter displays and can also be plotted versus time in a graph, creating an Ohm scope.



With the **SafeGround** protected ground option, the differential input of the WiFiScope WS6 DIFF is switched into a ground current protected single ended input. This allows to perform single ended measurements with e.g. an attenuating oscilloscope probe, without the risk of creating a short circuit to ground.



With the accompanying software the WiFiScope WS6 DIFF can be used as an oscilloscope, a spectrum analyzer, a true RMS voltmeter or a transient recorder. All instruments measure by sampling the input signals, digitizing the values, process them, save them and display them.

4.1 Differential input

Most oscilloscopes are equipped with standard, single ended inputs, which are referenced to ground. This means that one side of the input is always connected to ground and the other side to the point of interest in the circuit under test.

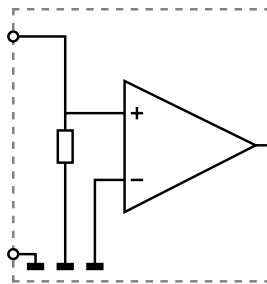

Figure 4.1: Single ended input

Therefore the voltage that is measured with an oscilloscope with standard, single ended inputs is always measured between that specific point and ground.

When the voltage is not referenced to ground, connecting a standard single ended oscilloscope input to the two points would create a short circuit between one of the points and ground, possibly damaging the circuit and the oscilloscope.

A safe way would be to measure the voltage at one of the two points, in reference to ground and at the other point, in reference to ground and then calculate the voltage difference between the two points. On most oscilloscopes this can be done

by connecting one of the channels to one point and another channel to the other point and then use the math function CH1 - CH2 in the oscilloscope to display the actual voltage difference.

There are some disadvantages to this method:

- a short circuit to ground can be created when an input is wrongly connected
- to measure one signal, two channels are occupied
- by using two channels, the measurement error is increased, the errors made on each channel will be combined, resulting in a larger total measurement error
- The Common Mode Rejection Ratio (CMRR) of this method is relatively low. If both points have a relative high voltage, but the voltage difference between the two points is small, the voltage difference can only be measured in a high input range, resulting in a low resolution

A much better way is to use an oscilloscope with a differential input.

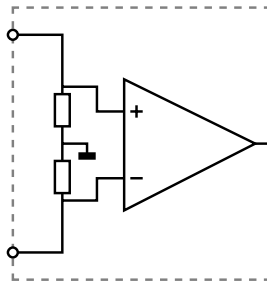

Figure 4.2: Differential input

A differential input is not referenced to ground, but both sides of the input are “floating”. It is therefore possible to connect one side of the input to one point in the circuit and the other side of the input to the other point in the circuit and measure the voltage difference directly.

Advantages of a differential input:

- No risk of creating a short circuit to ground
- Only one channel is required to measure the signal
- More accurate measurements, since only one channel introduces a measurement error
- The CMRR of a differential input is high. If both points have a relative high voltage, but the voltage difference between the two points is small, the voltage difference can be measured in a low input range, resulting in a high resolution

Disadvantages of a differential input:

- Higher sensitivity to external disturbances when used with standard measure leads

- Cannot be used in combination with a standard attenuating oscilloscope probe

4.1.1 SafeGround on each channel

The **SafeGround** protected ground feature of the WiFiScope WS6 DIFF allows to switch the differential inputs to single ended inputs. This enables to perform single ended measurements as well as using (attenuating) oscilloscope probes. **SafeGround** can be enabled for each channel individually.

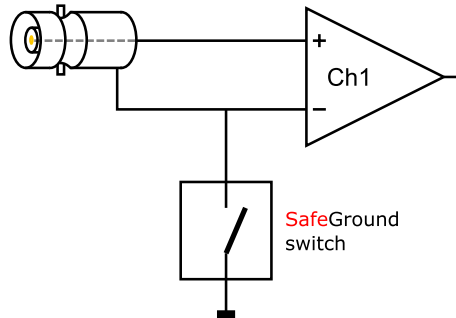



Figure 4.3: SafeGround

A button on each channel toolbar in the software allows to control the **SafeGround** state between differential  and single ended .

When **SafeGround** is enabled for a channel, the input is switched to single ended and the ground current of that input is real time monitored. When the ground current becomes too high (<500 mA), the ground connection is immediately (<100 ns) opened, protecting the input against short circuits to ground. Also a warning dialog is shown:

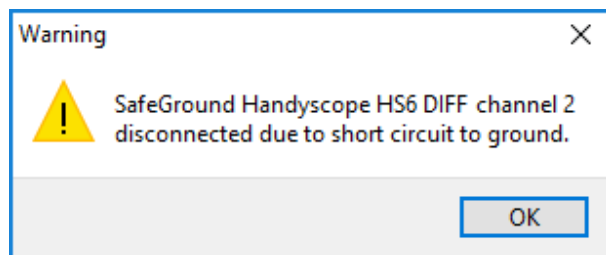

Figure 4.4: SafeGround warning

Once the short circuit is removed, **SafeGround** can be enabled again.

SafeGround protects your scope, your computer and your circuit under test against accidental wrong ground connections. The SafeGround protected ground feature is optionally available for the WiFiScope WS6 DIFF.

4.1.2 Differential attenuators

To increase the input range of the WiFiScope WS6 DIFF, it comes with a differential 1:10 attenuator for each channel. This differential attenuator is specially designed to be used with the WiFiScope WS6 DIFF.



Figure 4.5: Differential attenuator

For a differential input, both sides of the input need to be attenuated.

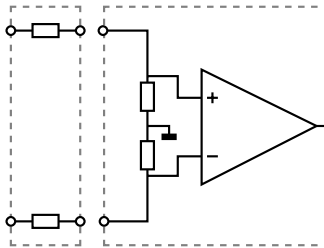

Figure 4.6: Differential attenuator matches with differential input

Standard oscilloscope probes and attenuators only attenuate one side of the signal path. These are not suitable to be used with a differential input. Using these on a differential input will have a negative effect on the CMRR and will introduce measurement errors.

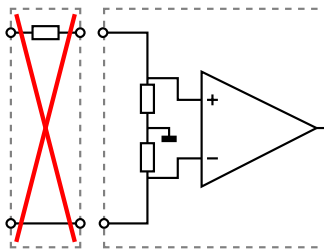

Figure 4.7: Standard probe is mismatch with differential input



The Differential Attenuator and the inputs of the WiFiScope WS6 DIFF are differential, which means that the outside of the BNCs are not grounded, but carry life signals.

When using the attenuator, the following points have to be taken into consideration:

- do not connect other cables to the attenuator than the ones that are supplied with the instrument
- do not touch the metal parts of the BNCs when the attenuator is connected to the circuit under test, they can carry a dangerous voltage. It will also influence the measurements and create measurement errors.
- do not connect the outside of the two BNCs of the attenuator to each other as this will short circuit a part of the internal circuit and will create measurement errors
- do not connect the outside of the BNCs of two or more attenuators that are connected to different channels of the WiFiScope WS6 DIFF to each other
- do not apply excessive mechanical force to the attenuator in any direction (e.g. pulling the cable, using the attenuator as handle to carry the WiFiScope WS6 DIFF, etc.)



When the WiFiScope WS6 DIFF is equipped with **SafeGround** and the inputs are switched to single ended, using the differential attenuator will lead to significant measurement errors. Use attenuating oscilloscope probes instead.

4.1.3 Differential test lead

Because the outside of the BNC is not connected to ground, using standard shielded coax BNC cables on the differential inputs will introduce measurement errors. The shield of the cable will act as receiving antenna for noise from the surrounding environment, making it visible in the measured signal.

Therefore, the WiFiScope WS6 DIFF comes with a special differential test lead, one for each channel. This test lead is specially designed to ensure a good CMRR and to be immune for noise from the surrounding environment.

The special differential test lead provided with the WiFiScope WS6 DIFF is heat resistant and oil resistant.



The differential test lead is only immune for noise when used on a differential input. When the WiFiScope WS6 DIFF is equipped with **SafeGround** and the inputs are switched to single ended, the differential test lead will **not** be immune for noise. Use standard shielded test leads or oscilloscope probes instead.

4.2 Sampling

When sampling the input signal, samples are taken at fixed intervals. At these intervals, the size of the input signal is converted to a number. The accuracy of this number depends on the resolution of the instrument. The higher the resolution, the smaller the voltage steps in which the input range of the instrument is divided. The acquired numbers can be used for various purposes, e.g. to create a graph.

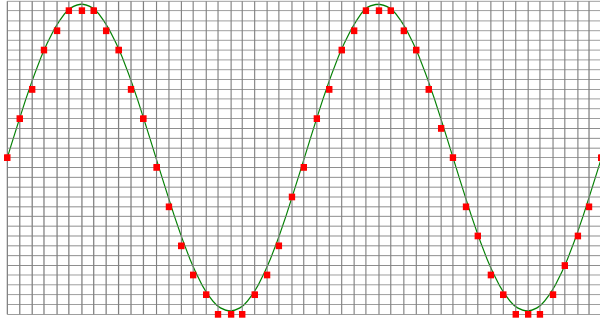

Figure 4.8: Sampling

The sine wave in figure 4.8 is sampled at the dot positions. By connecting the adjacent samples, the original signal can be reconstructed from the samples. You can see the result in figure 4.9.

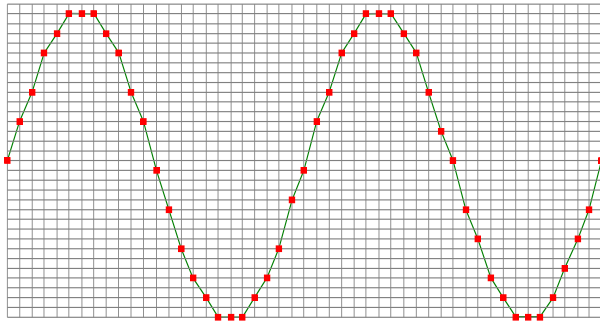

Figure 4.9: "connecting" the samples

4.3 Sampling rate

The rate at which the samples are taken is called the **sampling rate**, the number of samples per second. A higher sampling rate corresponds to a shorter interval between the samples. As is visible in figure 4.10, with a higher sampling rate, the original signal can be reconstructed much better from the measured samples.

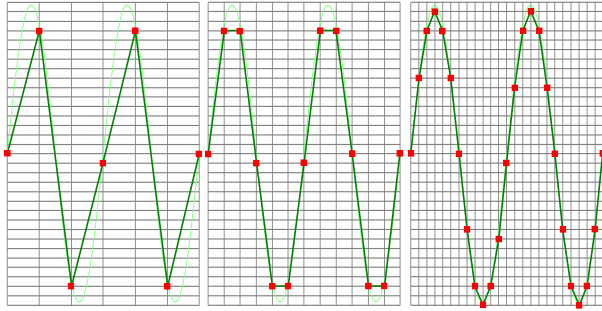

Figure 4.10: The effect of the sampling rate

The sampling rate must be higher than 2 times the highest frequency in the input signal. This is called the **Nyquist frequency**. Theoretically it is possible to reconstruct the input signal with more than 2 samples per period. In practice, 10 to 20 samples per period are recommended to be able to examine the signal thoroughly.

4.3.1 Aliasing

When sampling an analog signal with a certain sampling rate, signals appear in the output with frequencies equal to the sum and difference of the signal frequency and multiples of the sampling rate. For example, when the sampling rate is 1000 Sa/s and the signal frequency is 1250 Hz, the following signal frequencies will be present in the output data:

| Multiple of sampling rate | 1250 Hz signal | -1250 Hz signal |
|---------------------------|-------------------------------|------------------------|
| ... | | |
| -1000 | $-1000 + 1250 = \mathbf{250}$ | $-1000 - 1250 = -2250$ |
| 0 | $0 + 1250 = 1250$ | $0 - 1250 = -1250$ |
| 1000 | $1000 + 1250 = 2250$ | $1000 - 1250 = -250$ |
| 2000 | $2000 + 1250 = 3250$ | $2000 - 1250 = 750$ |
| ... | | |

Table 4.4: Aliasing

As stated before, when sampling a signal, only frequencies lower than half the sampling rate can be reconstructed. In this case the sampling rate is 1000 Sa/s, so we can only observe signals with a frequency ranging from 0 to 500 Hz. This means that from the resulting frequencies in the table, we can only see the 250 Hz signal in the sampled data. This signal is called an **alias** of the original signal.

If the sampling rate is lower than twice the frequency of the input signal, **aliasing** will occur. The following illustration shows what happens.

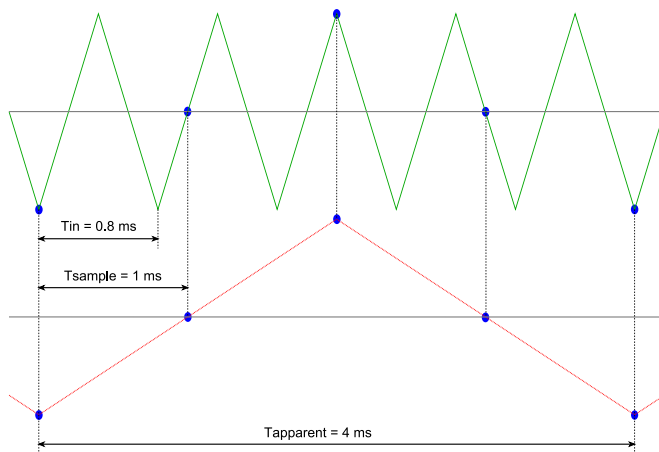

Figure 4.11: Aliasing

In figure 4.11, the green input signal (top) is a triangular signal with a frequency of 1.25 kHz. The signal is sampled with a rate of 1 kSa/s. The corresponding sampling interval is $1/1000\text{Hz} = 1\text{ms}$. The positions at which the signal is sampled are depicted with the blue dots. The red dotted signal (bottom) is the result of the reconstruction. The period time of this triangular signal appears to be 4 ms, which corresponds to an apparent frequency (alias) of 250 Hz ($1.25\text{ kHz} - 1\text{ kHz}$).



To avoid aliasing, always start measuring at the highest sampling rate and lower the sampling rate if required.

4.4 Digitizing

When digitizing the samples, the voltage at each sample time is converted to a number. This is done by comparing the voltage with a number of levels. The resulting number is the number corresponding to the level that is closest to the voltage. The number of levels is determined by the resolution, according to the following relation: $LevelCount = 2^{Resolution}$.

The higher the **resolution**, the more levels are available and the more accurate the input signal can be reconstructed. In figure 4.12, the same signal is digitized, using two different amounts of levels: 16 (4-bit) and 64 (6-bit).

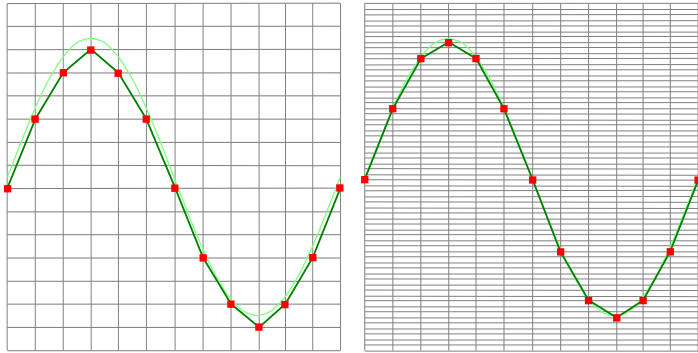

Figure 4.12: The effect of the resolution

The WiFiScope WS6 DIFF measures at e.g. 14 bit resolution ($2^{14}=16384$ levels). The smallest detectable voltage step depends on the input range. This voltage can be calculated as:

$$\text{VoltageStep} = \text{FullInputRange} / \text{LevelCount}$$

For example, the 200 mV range ranges from -200 mV to +200 mV, therefore the full range is 400 mV. This results in a smallest detectable voltage step of $0.400 \text{ V} / 16384 = 24.41 \mu\text{V}$.

4.5 Signal coupling

The WiFiScope WS6 DIFF has two different settings for the signal coupling: AC and DC. In the setting DC, the signal is directly coupled to the input circuit. All signal components available in the input signal will arrive at the input circuit and will be measured.

In the setting AC, a capacitor will be placed between the input connector and the input circuit. This capacitor will block all DC components of the input signal and let all AC components pass through. This can be used to remove a large DC component of the input signal, to be able to measure a small AC component at high resolution.



When measuring DC signals, make sure to set the signal coupling of the input to DC.

4.6 Probe compensation

When the inputs of the WiFiScope WS6 DIFF are switched to single-ended (SafeGround enabled), standard X1 / X10 attenuating oscilloscope probes can be used. These are 1x/10x selectable passive probes. This means that the input signal is passed through directly or 10 times attenuated.



When using an oscilloscope probe in 1:1 the setting, the bandwidth of the probe is only 6 MHz. The full bandwidth of the probe is only obtained in the 1:10 setting

The x10 attenuation is achieved by means of an attenuation network. This attenuation network has to be adjusted to the oscilloscope input circuitry, to guarantee frequency independency. This is called the low frequency compensation. Each time a probe is used on an other channel or an other oscilloscope, the probe must be adjusted.

Therefore the probe is equipped with a setscrew, with which the parallel capacity of the attenuation network can be altered. To adjust the probe, switch the probe to the x10 and attach the probe to a 1 kHz square wave signal. This signal is available at pin 3 of the 9 pin extension connector at the rear of the WiFiScope WS6 DIFF. Then adjust the probe for a square front corner on the square wave displayed. See also the following illustrations.

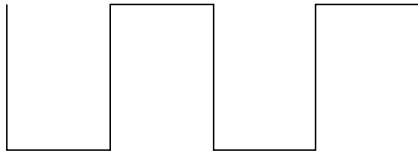

Figure 4.13: correct

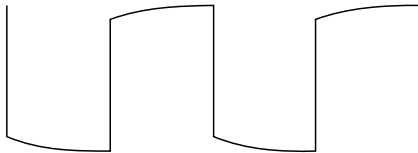

Figure 4.14: under compensated

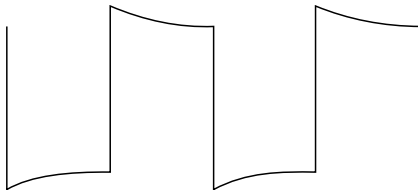

Figure 4.15: over compensated



Before connecting the WiFiScope WS6 DIFF to the computer via USB, the drivers need to be installed.

5.1 Introduction

To operate a WiFiScope WS6 DIFF via USB, a driver is required to interface between the measurement software and the instrument. This driver takes care of the low level communication between the computer and the instrument, through USB. When the driver is not installed, or an old, no longer compatible version of the driver is installed, the software will not be able to operate the WiFiScope WS6 DIFF properly or even detect it at all.

The installation of the USB driver is done in a few steps. Firstly, the driver has to be pre-installed by the driver setup program. This makes sure that all required files are located where Windows can find them. When the instrument is plugged in, Windows will detect new hardware and install the required drivers.

5.1.1 Where to find the driver setup

The driver setup program and measurement software can be found in the download section on TiePie engineering's website. It is recommended to install the latest version of the software and USB driver from the website. This will guarantee the latest features are included.

5.1.2 Executing the installation utility

To start the driver installation, execute the downloaded driver setup program. The driver install utility can be used for a first time installation of a driver on a system and also to update an existing driver.

The screen shots in this description may differ from the ones displayed on your computer, depending on the Windows version.

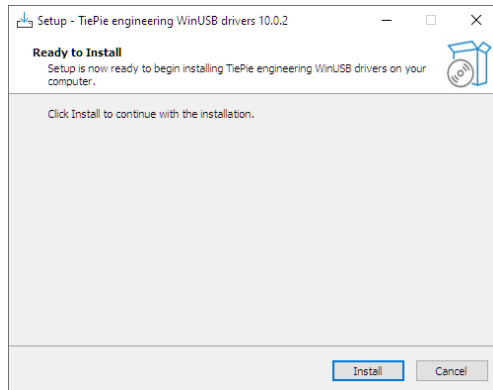

Figure 5.1: Driver install: step 1

When drivers were already installed, the install utility will remove them before installing the new driver. To remove the old driver successfully, **it is essential** that the WiFiScope WS6 DIFF is disconnected from the computer prior to starting the driver install utility. When the WiFiScope WS6 DIFF is used with an external power supply, this must be disconnected too.

Clicking **“Install”** will remove existing drivers and install the new driver. A *remove entry* for the new driver is added to the software applet in the Windows control panel.

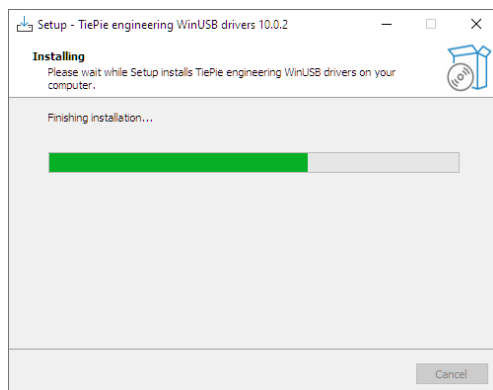

Figure 5.2: Driver install: Copying files



Figure 5.3: Driver install: Finished



Drivers have to be installed before the WiFiScope WS6 DIFF is connected to the computer via USB for the first time. See chapter 5 for more information.

6.1 Power the instrument

The WiFiScope WS6 DIFF can be powered in three different ways:

- by its built-in battery
- via an external power adapter, connected to the dedicated power input at the rear panel
- via the USB interface

When using the WiFiScope WS6 DIFF via its battery, no external power is required. The power consumption of the WiFiScope WS6 DIFF depends heavily on the settings of the instrument, when using higher sampling rates the instrument uses more power. Also when using larger record lengths, the power consumption increases. It is therefore not possible to give an exact operating time when running on its battery. When the battery is charged, the **Battery** indicator on the front panel will light up green.



When the battery level becomes low, the **Battery** indicator on the front panel will light up red.



It is recommended to recharge the battery. When the **Battery** indicator starts blinking red, the battery is almost empty and immediate recharging is required.

An indicator in the software will show the battery status and an estimation of the remaining operating time.

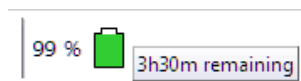

6.1.1 Charging the battery

Charging the battery is done by connecting the external power supply or by connecting the USB. When the battery is charging, the **Battery** indicator on the front panel will light up blue.



When connected to USB or external power, the battery will only be charged when the USB or external power can deliver enough power to operate the instrument and to charge the battery. When not enough power is available, the battery will be discharged. This is indicated by a blue blinking **Battery** indicator on the front panel of the instrument.

6.1.2 Long term storage

When storing the WiFiScope WS6 DIFF for a long time, it is recommended to first charge the battery to approximately 70 %. Do not store the WiFiScope WS6 DIFF for a long time with an empty battery or 100 % fully charged battery, as this may reduce battery capacity.

6.2 Instrument operation mode

The WiFiScope WS6 DIFF has a USB interface and a network interface, used to connect to the instrument via LAN or WiFi. The Power/Mode button at the front panel determines if the WiFiScope WS6 DIFF operates as USB instrument or as network (LAN or WiFi) instrument. The light in the Power/Mode button indicates in which mode the WiFiScope WS6 DIFF operates. When it is on, the network interface is enabled and the instrument operates as network (LAN or WiFi) instrument. When it is off, the network interface is disabled and the WiFiScope WS6 DIFF operates as USB instrument.

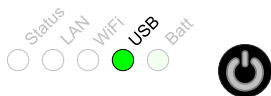

Power/Mode button light off: The WiFiScope WS6 DIFF can only be used via USB

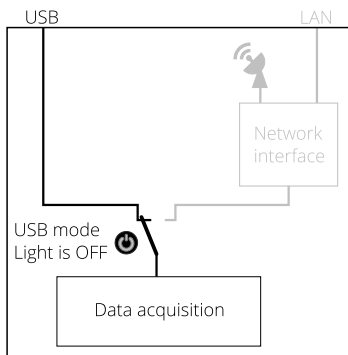

Power/Mode button light on: The WiFiScope WS6 DIFF can only be used via LAN or WiFi

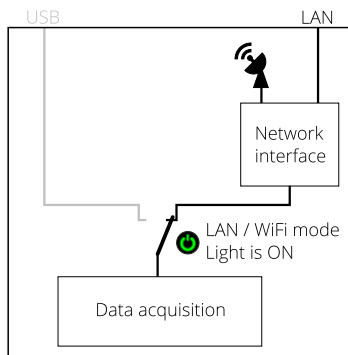

When the network interface of the WiFiScope WS6 DIFF is disabled, it will go to a low power state, to save the battery. To enable it again, a short press on the Power/Mode button is required.

When the WiFiScope WS6 DIFF is not connected to external power or USB and is not used for two days (network interface disabled), the WiFiScope WS6 DIFF switches to "Shipping mode", where the network interface is consuming no power at all. To wake up the WiFiScope WS6 DIFF from shipping mode, press the Power/Mode button for 2 seconds. When arriving from the factory, the WiFiScope WS6 DIFF will be in shipping mode.

When for some reason the network interface will not disable (the lights remain on), pressing the Power/Mode button for 3 seconds will force the network interface to be disabled.



For network operation, the WiFiScope WS6 DIFF uses UDP and TCP/IP **port 5450**. Make sure it is open in your fire wall settings.

6.3 Connect via LAN

To use the WiFiScope WS6 DIFF via the LAN, connect the WiFiScope WS6 DIFF LAN port on the rear panel to the LAN via a network cable.



The WiFiScope WS6 DIFF network interface must be enabled via the Power/Mode button on the front panel of the instrument. While the network interface is initializing, the Power/Mode button will blink, when the initialization is finished, the Power/Mode button will light up continuously.



When the LAN cable is connected, the LAN interface will attempt to get an address via DHCP. When that is successful, the **LAN** indicator on the front panel of the instrument will light up green.

When after 20 seconds no DHCP is found, the network interface will switch to link-local mode and use a link-local address. The **LAN** indicator on the front panel of the instrument will light up blue to indicate link-local mode. Link-local mode remains active until the LAN cable is removed and the LAN LED goes off. When the LAN cable is then reconnected, getting an address via DHCP is attempted again.

In the Multi Channel software, open the Manage instruments dialog and check **Search instruments in local network**.

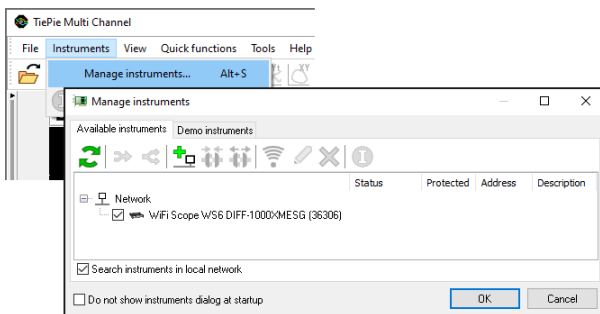

When searching the network is checked, the WiFiScope WS6 DIFF will appear. To connect the software to the WiFiScope WS6 DIFF check it and close the dialog with the **OK** button.

6.4 Connect via WiFi

There are several different ways to connect the computer to the WiFiScope WS6 DIFF via WiFi, depending on whether the computer/laptop has WiFi or not.

6.4.1 The computer/laptop has WiFi

To use the WiFiScope WS6 DIFF via WiFi, the network interface must be enabled via the Power/Mode button on the front panel of the instrument. While the network interface is initializing, the Power/Mode button will blink, when the initialization is finished, the Power/Mode button will light continuously.



When the computer does have WiFi, there are two different ways to connect to the instrument via WiFi.

Connect the WiFiScope WS6 DIFF to the local WiFi network

1. In the Multi Channel software open the Manage instruments dialog and check **Search instruments in local network**.
2. Place a check in front of the detected WiFiScope WS6 DIFF. It may take a few seconds to discover the instrument.
3. The software will now ask how to connect to the WiFiScope WS6 DIFF, select **Add WiFiScope to the 'WiFi' network**.
4. The connection is now set up, if required, the software will ask for the network password. The setup may take up to 30 seconds.

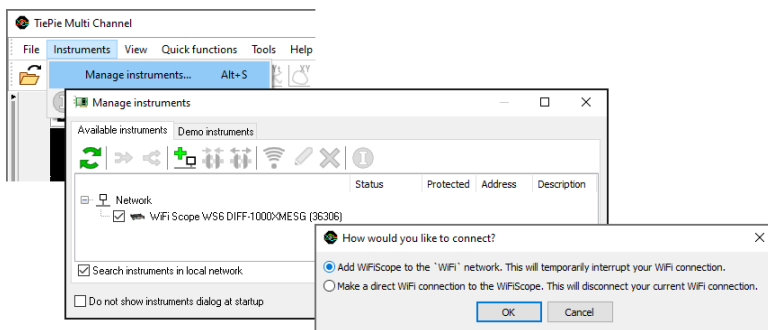

The WiFiScope WS6 DIFF is now connected to the local network via WiFi.

Connect to the WiFiScope WS6 DIFF directly using WiFi

1. In the Multi Channel software open the Manage instruments dialog and check **Search instruments in local network**.
2. Place a check in front of the detected WiFiScope WS6 DIFF. It may take a few seconds to discover the instrument.
3. If the computer is currently connected to a WiFi network, the software will ask how to connect to the WiFiScope WS6 DIFF, select **Make a direct WiFi connection to the WiFiScope..**
4. The connection is now set up. The setup may take up to 30 seconds.

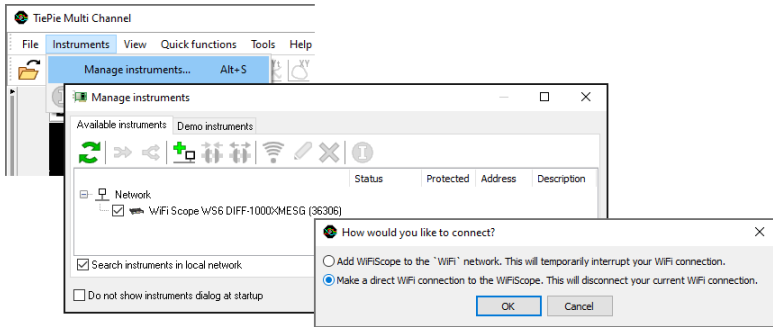

The WiFiScope WS6 DIFF is now setup as Access Point, to create its own WiFi network. The computer is disconnected from the local WiFi network and connected to the WiFiScope WS6 DIFF WiFi network. The computer will now no longer have internet access and/or access to network locations.

6.4.2 The computer/laptop has NO WiFi

When the computer has no WiFi, the WiFiScope WS6 DIFF will have to be connected to the local network. Therefore, the network interface of the WiFiScope WS6 DIFF must be enabled via the Power/Mode button on the front panel of the instrument. While the network interface is initializing, the Power/Mode button will blink, when the initialization is finished, the Power/Mode button will light continuously.



1. Connect the WiFiScope WS6 DIFF via a cable to the LAN as shown in the section **Connect via LAN**.
2. In the Multi Channel software open the Manage instruments dialog and check **Search instruments in local network**.
3. Place a check in front of the detected WiFiScope WS6 DIFF. It may take a few seconds to discover the instrument.

4. Click the WiFi button in the instruments manager to open the WiFiScope WS6 DIFF web interface.
5. Login to the web interface (default password = **tiepie**).
6. In the web interface, connect to the WiFi network using the **connect** button (and enter its password if required)
7. When successfully connected, close the web interface and disconnect the LAN cable.
8. The Multi Channel software will now detect the WiFiScope WS6 DIFF via WiFi, this may take a few seconds.

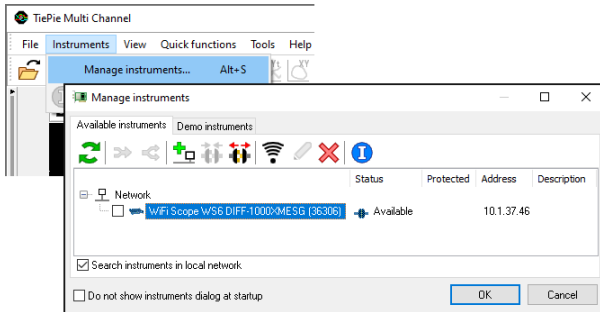

WiFiScope WS6
DIFF-1000XMESSG (36306)

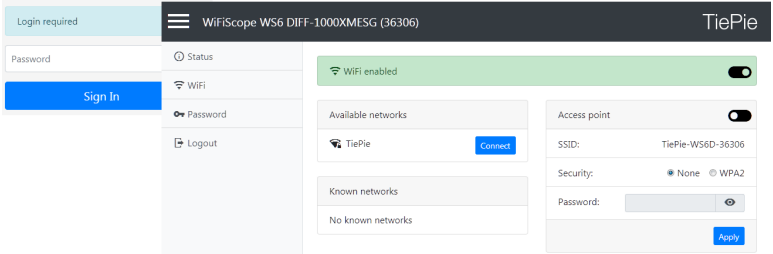

6.5 Connect via USB

To use the WiFiScope WS6 DIFF via USB, connect the WiFiScope WS6 DIFF USB port on the rear panel to the computer via a USB cable.



When using the instrument via USB, the network interface must be disabled via the Power/Mode button on the front panel of the instrument.

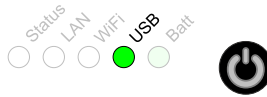

When a USB connection is established, this is indicated by a green lit **USB** indicator on the front panel of the instrument.

The software can now connect to the WiFiScope WS6 DIFF as local instrument.

6.5.1 Plug into a different USB port

When the WiFiScope WS6 DIFF is plugged into a different USB port, some Windows versions will treat the WiFiScope WS6 DIFF as different hardware and will install the drivers again for that port. This is controlled by Microsoft Windows and is not caused by TiePie engineering.

6.6 Operating conditions

The WiFiScope WS6 DIFF is ready for use as soon as the software is started. However, to achieve rated accuracy, allow the instrument to settle for 20 minutes. If the instrument has been subjected to extreme temperatures, allow additional time for internal temperatures to stabilize. Because of temperature compensated calibration, the WiFiScope WS6 DIFF will settle within specified accuracy regardless of the surrounding temperature.

7.1 Ground compensation cable

The WiFiScope WS6 DIFF is delivered with a special ground compensation cable, together with three corresponding ground clips in different sizes.



Figure 7.1: Ground compensation

The 1.5 m long ground compensation cable has a 2 mm banana plug at one end, that plugs into the small banana socket at the rear of the WiFiScope WS6 DIFF.



Figure 7.2: Rear ground connection

The other end has a 4 mm banana plug that connects to an alligator clip that can be connected to the ground of the test subject.

7.2 When using the the ground compensation cable

The ground compensation cable between WiFiScope WS6 DIFF and test subject is required when the WiFiScope WS6 DIFF is connected to the mains adapter and/or the USB cable, and the test subject is not grounded.

7.3 When is the ground compensation not required

The ground compensation cable between WiFiScope WS6 DIFF and test subject is not required when:

- When an input is switched to single ended (SafeGround is enabled)
- When the WiFiScope WS6 DIFF operates on battery power only
- When the input range of the WiFiScope WS6 DIFF is set to 20 V or higher

7.4 Why ground compensation?

Mains power supplies usually have noise filtering capacitors between the mains input and the output. When a device is powered by such power supply and it is not grounded, the device will float relative to the ground. This floating voltage can get as high as the mains voltage. This is however not dangerous because the current that can flow is very small.

When measuring with a WiFiScope WS6 DIFF, this floating voltage can affect your measurements because of the high input impedance of the WiFiScope WS6 DIFF, which is 1 MOhm.

When the WiFiScope WS6 DIFF is only battery powered, your measurements will not be affected, because the WiFiScope WS6 DIFF will also float on the floating voltage of the test subject.

When the WiFiScope WS6 DIFF is connected to the USB or connected to the mains, the floating voltage will cause a high common mode voltage at the input of the WiFiScope WS6 DIFF. The inputs of the WiFiScope WS6 DIFF will then clip and you will get strange measurement readings.

The common mode range of the WiFiScope WS6 DIFF is 2 V (input range 200 mV to 800 mV), 20 V (input range 2 V to 8 V) or 200 V (input range 20V to 80V). So if you measure in the 200mV range and the floating voltage becomes greater than 2 V, the input channel of the WiFiScope WS6 DIFF will clip and you will measure strange readings. If you measure in the 20 V range (or higher) you will suffer much less from the floating voltage because these are usually smaller than 200 V.

When the WiFiScope WS6 DIFF ground is connected to the ground of the test subject, they will both get the same ground level, so there will be no (high) common mode voltage due to floating. You will get no measurement errors then.

When more channels are required than one instrument can offer, multiple instruments can be combined into a larger combined instrument. To combine two or more instruments, the instruments need to be connected to each other using special cables.

i

Combining instruments is only available when the WiFIScope WS6 DIFF is connected to the computer via the USB. When used as network instrument (LAN or WiFi), combining is not possible.

The CMI (Combine Multiple Instruments) interface that is available by default on the WiFIScope WS6 DIFF provides an easy way to couple multiple oscilloscopes to one combined oscilloscope.

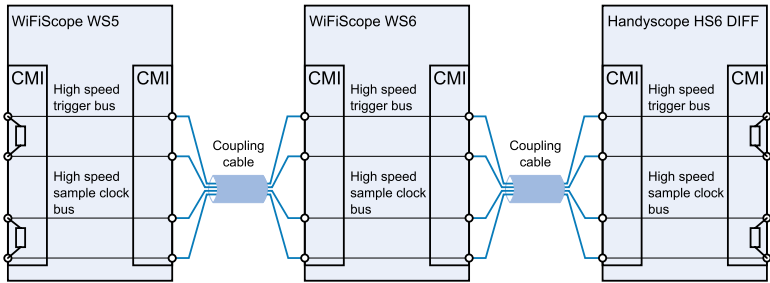

Figure 8.1: CMI diagram

The CMI interface supports automatic recognition of the instrument. The high speed trigger bus is automatically terminated with the correct impedance and the high speed sampling bus is automatically configured and terminated at the beginning and end of the bus. The high speed sampling bus takes care that each Handyscope is fully synchronized to ensure that even at the highest sampling rate the instruments operate at the same sample clock (0 ppm clock error!). The connection order when combining multiple instruments is not important. The CMI interface has built-in intelligence to detect the connections and terminate all buses properly at both ends of the bus. So instruments can be connected to each other in random order. Placing terminators and determining the proper connection order is not required!

Advantages of the CMI (Combine Multiple Instruments) interface are:

- automatic instrument recognition,
- automatic creation and termination of the high speed trigger bus,
- automatic creation and termination of the high speed sampling bus,
- automatic master/slave setting of the sampling clock bus.

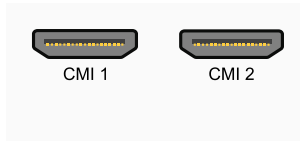

Figure 8.2: CMI connectors

Connecting is done by daisy chaining the CMI connectors of the instruments prior to starting the software, using special coupling cables (order number TP-C50H). The software will detect how the instruments are connected to each other and will automatically terminate the connection bus. The software will combine the connected instruments to one large instrument. The combined instruments will sample using the same clock, with a deviation of 0 ppm.



Figure 8.3: Multiple WiFiScope WS6 DIFFs combined

A 20 channel instrument is easily made by connecting five WiFiScope WS6 DIFFs to each other.

8.1 Limitation

Our 2 channel CMI instruments are:

| | |
|---------------|---------------|
| Handscope HS5 | WiFiScope WS5 |
|---------------|---------------|

Our 4 channel CMI instruments are:

| | |
|--------------------|--|
| Handscope HS6 | Automotive Test Scope ATS610004D-XMSG |
| Handscope HS6 DIFF | Automotive Test Scope ATS605004D-XMS |
| WiFiScope WS6 | Automotive Test Scope ATS610004DW-XMSG |
| WiFiScope WS6 DIFF | Automotive Test Scope ATS605004DW-XMS |

When combining one or more 2 channel instruments with 4 channel instruments, the daisy chained CMI bus must begin or end with a 4 channel instrument. Additionally, the maximum sampling rate is limited to 100 MSa/s at 14 bit resolution.

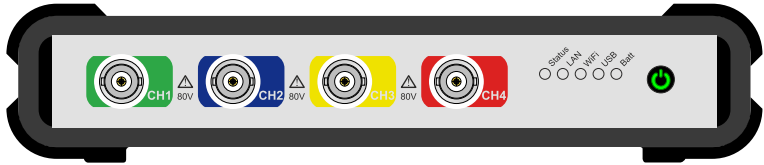

Figure 9.1: Front panel

9.1 Channel input connectors



The CH1 – CH4 Isolated BNC connectors are the main inputs of the acquisition system. The isolated BNC connectors are not connected to the ground of the WiFiScope WS6 DIFF.

9.2 EMI probe grounding

A WiFiScope WS6 DIFF with the EMI option installed has a 2 mm banana socket next to the Ch1 input. It is used to ground the EMI probe.

9.3 Power/Mode button

The **Power/Mode** button is situated at the right of the front of the instrument. It is used to switch the mode of the WiFiScope WS6 DIFF between USB use and LAN / WiFi use. To use the WiFiScope WS6 DIFF via LAN or WiFi, the network interface must be enabled, by pressing the Power/Mode button. When using the WiFiScope WS6 DIFF via USB, the network interface must be disabled, by pressing the Power/Mode button again. The Power/Mode button can have the following states:

-  When off, the network module is disabled, the instrument can be connected via USB.
-  When blinking, the network module is initializing.
-  When lit continuously green, the network module is ready, the instrument can be connected via LAN or WiFi.

9.4 Status indicators

The WiFiScope WS6 DIFF has a number of status indicators, which can be lit to indicate the status of the instrument.

9.4.1 Status

The status light indicates if the instrument is being used by software or not.

- When lit continuously green, the instrument is not being used, it is available to be opened in software.
- When lit continuously blue, the instrument is in use, it is already opened in software.

9.4.2 LAN

When the **LAN** indicator is lit, the instrument is connected to a wired network.

- When lit continuously green, the instrument has received a network address via DHCP.
- When lit continuously blue, the instrument is assigned a link local address.

9.4.3 WiFi

When the **WiFi** indicator is lit, the instrument is connected to the computer and measuring via a WiFi network. The color indicates how the instrument operates:

- When blinking green, the instrument is trying to establish a WiFi connection to an existing network.
- When lit continuously green, the instrument has established a connection to an existing WiFi network and has received a network address via DHCP.
- When lit continuously blue, the instrument acts as WiFi access point. Connect the computer via WiFi to the network that the instrument creates.
- When lit continuously red, WiFi is disabled in the instrument's web interface.

9.4.4 USB

When the **USB** indicator is lit, the instrument is connected to the computer via USB.

- When lit continuously green, the instrument is in operational state.
- When lit continuously blue, the instrument is in firmware update mode.

9.4.5 Batt

The **Batt** indicator can indicate various different states:

- When lit continuously green and the external power is connected, the battery is full. When external power is not connected, the battery is being discharged, its level is higher than 5 %.
- When lit continuously blue, the battery is charging.
- When blinking blue, external power or USB power is connected, but cannot deliver enough power to charge the battery.
- When lit continuously red, the battery level is below 5 %, charging is recommended.
- When blinking red, the battery level is below 2 %, immediate charging is required.
- When fast cycling all colors, the battery is not found or is defective. Contact support@tiepie.nl.

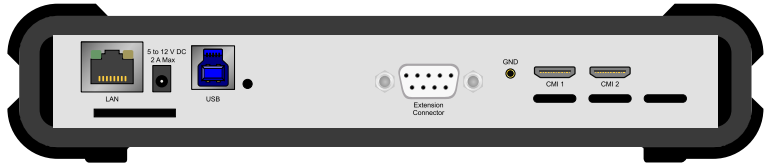

Figure 10.1: Rear panel

10.1 Power

The WiFiScope WS6 DIFF can be powered by its internal battery, via a dedicated power input at the rear panel and via the USB interface.

To charge the battery, connect the external power supply. The battery can also be charged via the USB, but only if the USB can deliver enough power to operate the instrument and charge the battery. If not enough power for both is available, the battery will not be charged, but will be used by the instrument and be discharged. The Batt status light at the front panel will then blink blue.

The specifications of the dedicated power connector are:



| Pin | Dimension | Description |
|-----------------|-----------|-------------|
| Center pin | Ø1.3 mm | positive |
| Outside bushing | Ø3.5 mm | ground |

Figure 10.2: Power connector

The following minimum and maximum voltages apply to the power inputs:

- **Minimum:** 5 V_{DC} / 2 A
- **Maximum:** 12 V_{DC} / 2 A

10.1.1 Power adapter

The WiFiScope WS6 DIFF comes with an external 12 V_{DC} 2 A power adapter that can be connected to any mains power net that supplies 100 – 240 V_{AC}, 50 – 60 Hz. The external power adapter can be connected to the dedicated power connector.



Figure 10.3: Power adapter

10.2 USB

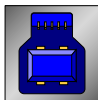

USB

Figure 10.4: USB connector

The WiFiScope WS6 DIFF is equipped with a USB 3.0 Super speed (5 Gbit/s) interface with a USB 3 type B Super speed socket. It will also work on a computer with a USB 2.0 interface, but will then operate at 480 Mbit/s.

10.3 LAN

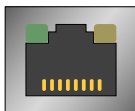

LAN

Figure 10.5: LAN connector

The WiFiScope WS6 DIFF is equipped with a 1 Gbit LAN interface with RJ45 socket.

10.4 Factory reset

Right next to the LAN connector a reset button is located to perform a factory reset on the WiFiScope WS6 DIFF. The factory reset clears all user settings like wifi networks and login codes. To perform a factory reset, perform the following steps:

- If the Power/Mode button on the front is lit, press it to switch it off.
- Press the reset button on the rear and keep it pressed.
- While keeping the reset button pressed, press the Power/Mode button on the front again, its light will start blinking.
- Keep the reset button pressed until the Power/Mode button starts to light continuously, then release the reset button. This may take up to 20 seconds.

The instrument is now back in factory state as when it left the factory. It is ready to be used again in the same way as indicated in chapter 6.2.

10.5 Extension Connector



Figure 10.6: Extension connector

A 9 pin female D-sub connector is available at the back of the WiFiScope WS6 DIFF containing the following signals:

| Pin | Description | Pin | Description | Pin | Description |
|-----|----------------|-----|-------------|-----|-----------------------------|
| 1 | EXT 1 (LVTTTL) | 4 | reserved | 7 | NC |
| 2 | EXT 2 (LVTTTL) | 5 | reserved | 8 | Power OUT (see description) |
| 3 | Probe Cal | 6 | GND | 9 | reserved |

Table 10.1: Pin description Extension connector

Pins EXT 1 and EXT 2 are equipped with internal 1 kOhm pull-up resistors to 2.5 V. These pins can simultaneously be used as inputs and outputs. Each pin can be configured as external digital trigger input for the acquisition system of the WiFiScope WS6 DIFF.

Pin 3, Probe Cal, has a 1 kHz, -1 V to 1 V square wave signal that can be used to perform probe frequency compensations.

Pin 8, Power OUT, is 5 V_{DC} and can supply 100 mA and is available when the Power/Mode button of the WiFiScope WS6 DIFF is switched on.

10.6 Ground connector

The WiFiScope WS6 DIFF has a special 2 mm banana ground connector, to connect a ground compensation lead.



Figure 10.7: Ground connector

For a description on how to use the Ground connector and ground compensation lead, see chapter 7.

10.7 CMI

The WiFiScope WS6 DIFF has two Combine Multiple Instruments interface (CMI) connectors at the rear of the instrument. These connectors are used to combine multiple instruments to a single combined instrument to perform synchronized measurements. This requires a TP-C50H coupling cable per two instruments.

They can also be used to get an external sampling clock OUT.



Figure 10.8: CMI connector

| Pin | Description |
|-----|----------------------|
| 1 | GND |
| 2 | EXT CLK OUT P (LVDS) |
| 3 | EXT CLK OUT N (LVDS) |

Table 10.2: Pin description CMI connector



The CMI connectors use HDMI type C sockets, but are not HDMI compliant. They can not be used to connect an HDMI device to the WiFiScope WS6 DIFF.

10.8 Ventilation slots

Below the LAN connector and power connector a ventilation slot is located, with a fan behind it. And below the CMI connectors three smaller ventilation slots are located.

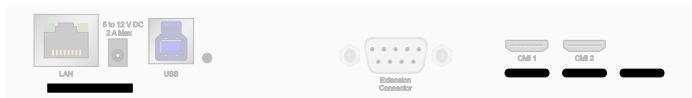

Figure 10.9: Ventilation slots



Do not block the ventilation slots as this may cause the WiFiScope WS6 DIFF becoming too hot. Do not insert objects in the ventilation slot as this may damage the fan.

The network module of the WiFiScope WS6 DIFF has internal firmware, that determines its capabilities, when the WiFiScope WS6 DIFF is connected via LAN or WiFi. This firmware can be updated to add new functionality. This chapter describes the steps to update the firmware of the WiFiScope WS6 DIFF.

11.1 Preparation



Updating the firmware will clear all entered WiFi network logins.

First make sure that the firmware update image file is obtained and stored on a readily available location on the computer.

To update the firmware, a USB connection between the computer and the WiFiScope WS6 DIFF is required, make sure that the USB cable for the WiFiScope WS6 DIFF is available. Plug the USB cable in a free USB port of the computer, but **not** connect it to the WiFiScope WS6 DIFF yet.

- Start the latest version of the Multi Channel software, available from the website.
- In the Multi Channel software, open the **Manage instruments** window, via the **Instruments** menu or hotkey **Alt + S**
- Disconnect the WiFiScope WS6 DIFF from external power and, when used, from the wired LAN.
- Switch the Power/Mode button **off**. All indicators on the front panel of the WiFiScope WS6 DIFF are now off.



11.2 Switching to firmware update mode

- Press the Power/Mode button and keep it pressed.
- When the battery indicator lights up, plug the USB cable in the instrument. The USB light will now turn blue. The color of the Batt light is not relevant.



- Now release the Power/Mode button. All lights now turn blue. The Batt light is still not relevant. The WiFiScope WS6 DIFF is now in firmware update mode.



11.3 Updating the firmware

The **Manage instruments** window now has an additional tab **Update firmware**, switch to that tab page.

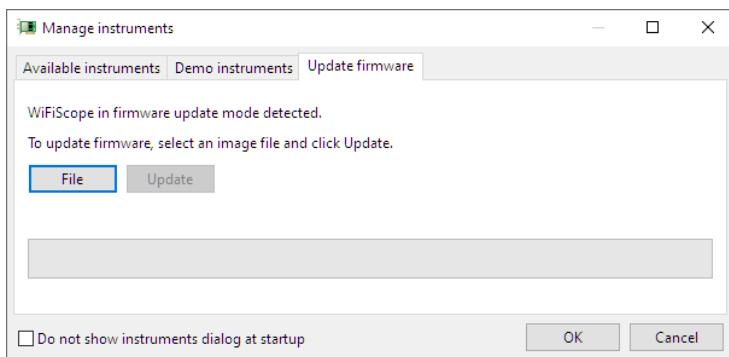

Click the **"File"** button and in the File open dialog, browse to the location of the firmware image file and select the image file. The **"Update"** button is now enabled, click it to start the firmware update process.

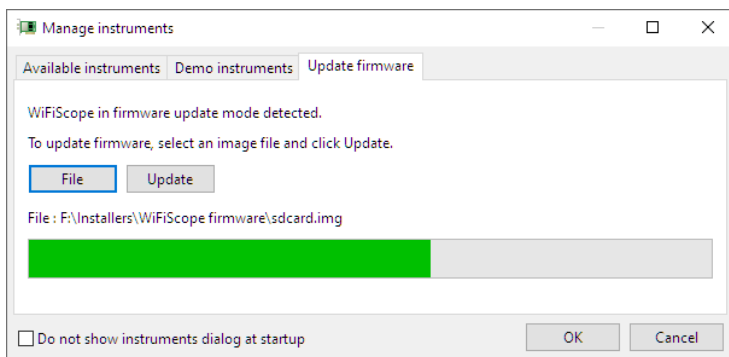

A progress bar will show the status of the update. The update process will take approximately 1 minute. When the update is ready, a notification will be shown.

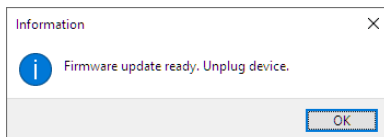

Now unplug the instrument from the USB. The WiFiScope WS6 DIFF can now be used via LAN and WiFi again.

The WiFiScope WS6 DIFF has a web interface in which status information of the instrument can be found and in which WiFi network settings can be changed.

12.1 Enter the web interface

1. Connect the WiFiScope WS6 DIFF via a cable to the LAN.
2. In the Multi Channel software open the Manage instruments dialog and check **Search instruments in local network**.
3. Place a check in front of the detected WiFiScope WS6 DIFF. It may take a few seconds to discover the instrument.
4. Click the WiFi button in the istruments manager to open the WiFiScope WS6 DIFF web interface.
5. Login to the web interface (default password = **tiepie**).

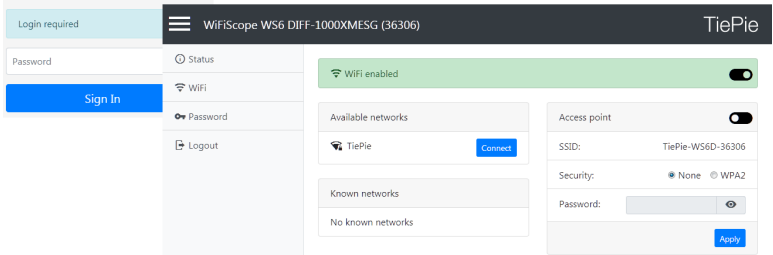
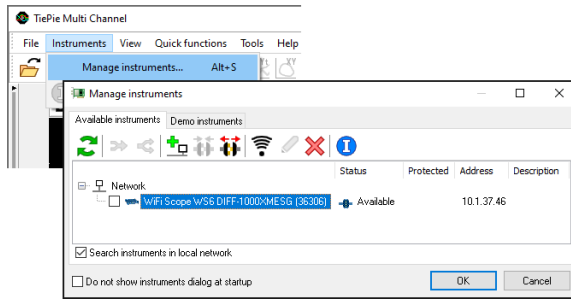

12.2 Setting a fixed IP address

By default, the WiFiScope WS6 DIFF is setup to receive an IP address by the DHCP server in the local network. When the WiFiScope WS6 DIFF is connected via wired LAN, it is possible to set a fixed IP address, for the instrument to use.

The settings for a fixed IP address are found on the **Status** page in the web interface.

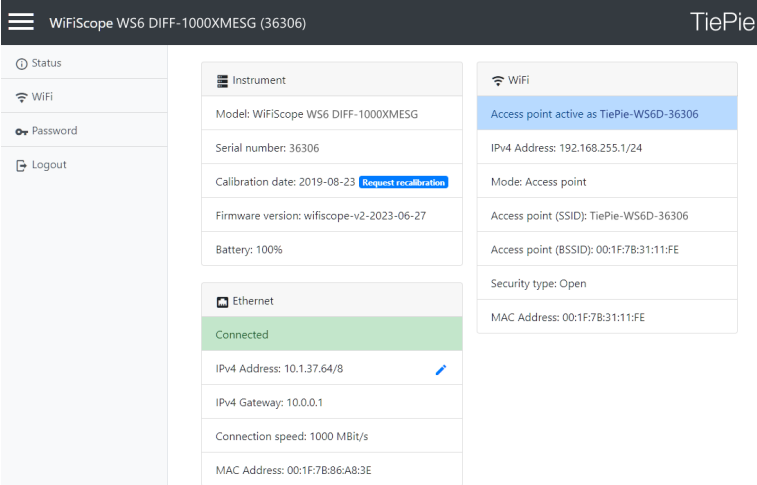

The screenshot shows the web interface for a WiFiScope WS6 DIFF (1000XMESSG, 36306). The interface is divided into three main sections: Instrument, Ethernet, and WiFi.

- Instrument:** Model: WiFiScope WS6 DIFF-1000XMESSG, Serial number: 36306, Calibration date: 2019-08-23 (with a "Request recalibration" button), Firmware version: wifiscope-v2-2023-06-27, Battery: 100%.
- Ethernet:** Status: Connected. IPv4 Address: 10.1.37.64/8 (with an edit icon), IPv4 Gateway: 10.0.0.1, Connection speed: 1000 MBit/s, MAC Address: 00:1F:7B:86:A8:3E.
- WiFi:** Status: Access point active as TiePie-WS6D-36306. IPv4 Address: 192.168.255.1/24, Mode: Access point, Access point (SSID): TiePie-WS6D-36306, Access point (BSSID): 00:1F:7B:31:11:FE, Security type: Open, MAC Address: 00:1F:7B:31:11:FE.

Clicking the edit button (pen symbol) behind the IPv4 address opens the IPv4 address edit page.

By default, the **Method** is set to **Automatic (DHCP)**, where the DHCP server in the network assigns an IP address to the WiFiScope WS6 DIFF.

When the **Method** is set to **Manual**, the following settings can be defined manually, to your preferences:

- IP address
- Subnet mask
- Gateway
- DNS server

When the WiFiScope WS6 DIFF is connected via WiFi, it is not possible to set a fixed IP address.

To achieve rated accuracy, allow the instrument to settle for 20 minutes. When subjected to extreme temperatures, allow extra time for internal temperatures to stabilize. Because of temperature compensated calibration, the WiFiScope WS6 DIFF will settle within specified accuracy regardless of the surrounding temperature.

13.1 Definition of accuracy

The accuracy of an input channel is defined as a percentage of the Full Scale range. The Full Scale range runs from *-range* to *range* and is effectively $2 * range$. When the input range is set to 4 V, the Full Scale range is $-4 V$ to $4 V = 8 V$. Additionally a number of Least Significant Bits is incorporated. The accuracy is determined in the highest resolution.

When the accuracy is specified as $\pm 0.25\%$ of the Full Scale range ± 1 LSB, and the input range is 4 V, the maximum deviation the measured value can have is $\pm 0.25\%$ of $8 V = \pm 20$ mV. ± 1 LSB equals $8 V / 65536$ (= number of LSB at 16 bit resolution) = $\pm 122 \mu V$. Therefore the measured value will be between 20.122 mV lower and 20.122 mV higher than the actual value. When e.g. applying a 3.75 V signal and measuring it in the 4 V range, the measured value will be between 3.770122 V and 3.729878 V.

13.2 Acquisition system

| | | | |
|----------------------------------|---|---|---|
| Number of input channels | 4 analog | | |
| CH1, CH2, CH3, CH4 | Isolated BNC, female | | |
| Type | Differential | | |
| Resolution | 8, 12, 14, 16 bit user selectable | | |
| Accuracy | 0.25% of full scale ± 1 LSB | | |
| Ranges (full scale) | ± 200 mV ± 2 V ± 20 V | ± 400 mV ± 4 V ± 40 V | ± 800 mV ± 8 V ± 80 V |
| Coupling | AC/DC | | |
| Noise | 305 μV_{RMS} (200 mV range, 12 bit, 50 MSa/s) 90 μV_{RMS} (200 mV range, 16 bit, 6.25 MSa/s) | | |
| Impedance | | | |
| SafeGround disabled | 2 M Ω / 12 pF ± 1 % | | |
| SafeGround enabled | 1 M Ω / 20 pF ± 1 % | | |
| Maximum voltage | 200 V (DC + AC peak <10 kHz) | | |
| Maximum Common Mode voltage | 200 mV to 800 mV ranges : 2 V 2 V to 8 V ranges : 20 V 20 V to 80 V ranges : 200 V | | |
| Common Mode Rejection Ratio | -47 dB | | |
| Bandwidth | WS6D-1000 | WS6D-500 | WS6D-200 |
| -3 dB, at 75 % of full scale | 250 MHz | 250 MHz | 250 MHz |
| Limit, selectable per channel | Off (250 MHz) 150 MHz 100 MHz 50 MHz | Off (250 MHz) 150 MHz 100 MHz 50 MHz | Off (250 MHz) 150 MHz 100 MHz 50 MHz |
| AC coupling cut off freq. (-3dB) | ± 1.5 Hz | | |

Acquisition system (continued)

| | | | |
|---------------------------------------|--|---|---|
| SureConnect | Optionally available (option S) | | |
| Maximum voltage on connection | 200 V (DC + AC peak <10 kHz) | | |
| Resistance measurement | Optionally available (option S) | | |
| Ranges | 1 k Ω 10 k Ω 100 k Ω 1 M Ω | 2 k Ω 20 k Ω 200 k Ω 2 M Ω | 5 k Ω 50 k Ω 500 k Ω |
| Accuracy | 1% | | |
| Response time (to 95%) | <10 μ s | | |
| SafeGround | Optionally available (option G) | | |
| Maximum voltage on connection | 200 V (DC + AC peak <10 kHz) | | |
| Maximum switch off current | 500 mA | | |
| Response time | <100 ns | | |
| Maximum sampling rate | WS6D-1000 | WS6D-500 | WS6D-200 |
| 8 bit | | | |
| Measuring 1 channel | 1 GSa/s | 500 MSa/s | 200 MSa/s |
| Measuring 2 channels | 500 MSa/s | 200 MSa/s | 100 MSa/s |
| Measuring 3 or 4 channels | 200 MSa/s | 100 MSa/s | 50 MSa/s |
| 12 bit | | | |
| Measuring 1 channel | 500 MSa/s | 200 MSa/s | 100 MSa/s |
| Measuring 2 channels | 200 MSa/s | 100 MSa/s | 50 MSa/s |
| Measuring 3 or 4 channels | 100 MSa/s | 50 MSa/s | 20 MSa/s |
| 14 bit | 100 MSa/s | 50 MSa/s | 20 MSa/s |
| 16 bit | 6.25 MSa/s | 3.125 MSa/s | 1.25 MSa/s |
| Maximum streaming rate ^{6,7} | WS6D-1000 | WS6D-500 | WS6D-200 |
| 8 bit | | | |
| Measuring 1 channel | 200 MSa/s ¹ | 100 MSa/s ¹ | 40 MSa/s |
| Measuring 2 channels | 100 MSa/s ² | 50 MSa/s ² | 20 MSa/s |
| Measuring 3 or 4 channels | 50 MSa/s ³ | 25 MSa/s ³ | 10 MSa/s |
| 12 bit | | | |
| Measuring 1 channel | 100 MSa/s ² | 50 MSa/s ² | 20 MSa/s |
| Measuring 2 channels | 50 MSa/s ³ | 25 MSa/s ³ | 10 MSa/s |
| Measuring 3 or 4 channels | 25 MSa/s ⁴ | 12.5 MSa/s ⁴ | 5 MSa/s |
| 14 bit | | | |
| Measuring 1 channel | 100 MSa/s ² | 50 MSa/s ² | 20 MSa/s |
| Measuring 2 channels | 50 MSa/s ³ | 25 MSa/s ³ | 10 MSa/s |
| Measuring 3 or 4 channels | 25 MSa/s ⁴ | 12.5 MSa/s ⁴ | 5 MSa/s |
| 16 bit | 6.25 MSa/s ⁵ | 3.125 MSa/s | 1.25 MSa/s |
| | ¹ \leq 40 MSa/s when connected to USB2 ² \leq 20 MSa/s when connected to USB2 ³ \leq 10 MSa/s when connected to USB2 ⁴ \leq 5 MSa/s when connected to USB2 ⁵ \leq 3.125 MSa/s when connected to USB2, measuring 2 or more channels ⁶ On some computers, the highest streaming rates may not be available, due to computer restrictions. ⁷ When connected through LAN or WiFi, the maximum streaming rates are limited and depend on the speed and load of the network | | |

Acquisition system (continued)

| | | | |
|---------------------------|--|-------------------|------------------------|
| Sampling source | | | |
| Internal | TCXO | | |
| Accuracy | ±0.0001% | | |
| Stability | ±1 ppm over 0 °C to +55 °C | | |
| Time base aging | ±1 ppm per year time base aging | | |
| External | | | |
| Input frequency | LV-TTL (2.5 V), on Extension connector | | |
| | 10 MHz ±1 % | | |
| | 16.369 MHz ±1 % | | |
| Memory | | | |
| | Standard model | XM option via USB | XM option via LAN/WiFi |
| 8 bit | | | |
| Measuring 1 channel | 1 MS | 256 MS | 64 MS |
| Measuring 2 channels | 512 KS | 128 MS | 32 MS |
| Measuring 3 or 4 channels | 256 KS | 64 MS | 16 MS |
| 12, 14, 16 bit | | | |
| Measuring 1 channel | 512 KS | 128 MS | 32 MS |
| Measuring 2 channels | 256 KS | 64 MS | 16 MS |
| Measuring 3 or 4 channels | 128 KS | 32 MS | 8 MS |

13.3 Trigger system

Triggering is only available when the WiFiScope WS6 DIFF operates in block mode, not when operating in streaming mode

| | | | |
|--------------------------|--|--|--|
| System | Digital, 2 levels | | |
| Source | CH1, CH2, CH3, CH4, digital external, OR | | |
| Trigger modes | Rising / Falling / Any edge, Inside / Outside window, Enter / Exit window, Pulse width, Interval | (time conditions only on Ch1) (time conditions only on Ch1) (only on Ch1) (only on Ch1) | |
| Level adjustment | 0 to 100% of full scale | | |
| Hysteresis adjustment | 0 to 100% of full scale | | |
| Resolution | 0.024 % (12 bits)/0.006 % (14/16 bits) | | |
| Pre trigger | 0 to selected record length, 1 sample resolution | | |
| Post trigger | 0 to selected record length, 1 sample resolution | | |
| Trigger hold-off | 0 to 64 MSamples, 1 sample resolution | | |
| Trigger delay | 0 to 16 GSamples, 1 sample resolution | | |
| Digital external trigger | | | |
| Input | Extension connector pins 1 and 2 | | |
| Range | 0 to 2.5 V (TTL) | | |
| Coupling | DC | | |
| Jitter | ≤ 1 sample | | |

13.4 Probe calibration

| | |
|-----------|--|
| Output | Extension connector pins 3 (signal) and 6 (ground) |
| Signal | Square wave |
| Level | -1 V to 1 V |
| Frequency | 1 kHz |

13.5 Power

| | |
|-----------------------------|---|
| Power | From USB, external input or built-in battery |
| Consumption | 12 V _{DC} , 2 A max |
| Internal battery | Li-ion |
| Capacity | 7000 mAh, 3.7 V |
| Operating time | Strongly depending on instrument setup, ≥ 3 hours |
| Power adapter | External |
| Input | 110 to 240 V _{AC} , 50 to 60 Hz, 500 mA |
| Output | 12 V _{DC} , 2 A |
| Dimension | |
| Height | 57 mm / 2.2" |
| Width | 30 mm / 1.2" |
| Length | 88 mm / 3.4" |
| Cable length | 1.8 m / 70" |
| Order number | TP-UES24LCP-120200SPA |
| Replaceable mains plugs for | EU, US, AU, UK |

13.6 Physical

| | |
|-----------------|--------------------|
| Height | 44 mm / 1.7" |
| Length | 187 mm / 7.4" |
| Width | 215 mm / 8.5" |
| Weight | 751 g / 26.5 ounce |
| USB cord length | 1.5 m / 59" |

13.7 Multi-instrument synchronization

| | | |
|---------------------------------|---|-----------|
| Using CMI | Combining instruments is only available when all instruments are connected via USB. When connected via LAN or WiFi, combining via CMI is not available. | |
| Maximum number of instruments | Limited by available number of USB ports | |
| Synchronization accuracy | 0 ppm | |
| CMI interface | 2x, CMI 1, CMI 2 | |
| Required coupling cable | TP-C50H Coupling cable CMI | |
| Maximum coupling cable length | 50 cm | |
| Using WCMI | | |
| Maximum number of instruments | No limitation | |
| Required coupling module | WCMI-8 and WCMI-9 | |
| Clock synchronization accuracy | ≤ 1 ppm, typical ≤ 0.2 ppm | |
| Trigger jitter at sample rate * | ≤ 1 MSa/s | > 1 MSa/s |
| 2 x "5" | ≤ ±2 samples | ≤ ±2 μs |
| "5" and "6" | | |
| Trigger source = "5" | ≤ ±2 samples | ≤ ±2 μs |
| Trigger source = "6" | ≤ ±8 samples | ≤ ±8 μs |
| 2 x "6" | ≤ ±8 samples | ≤ ±8 μs |

* "5" = WiFiScope W55 or Handyscope HS5

"6" = WiFiScope W56 (DIFF) or Handyscope HS6 (DIFF)

13.8 I/O connectors

| | |
|---------------------|--------------------------------|
| CH1, CH2, CH3, CH4 | Isolated BNC, female |
| USB | USB3 type B Super Speed socket |
| LAN | RJ45 socket |
| Extension connector | D-sub 9 pins female |
| Power | 3.5 mm power socket |
| CMI connectors 1–2 | HDMI type C socket |

13.9 Interface

| | |
|------------------------------|--|
| USB | USB 3.0 SuperSpeed (5 Gbit/s) (USB 2.0 HighSpeed (480 Mbit/s) compatible) |
| Network | |
| LAN | 1 Gbps |
| WiFi | 802.11 |
| Network port (TCPIP and UDP) | 5450 (IANA assigned) |

13.10 System requirements

| | |
|-------------------|--------------------------|
| PC I/O connection | USB 2.0 or newer |
| Operating System | Windows 10 / 11, 64 bits |

13.11 Environmental conditions

| | Ambient Temperature | Relative Humidity |
|----------------------------|---------------------|---------------------------|
| Operating with charging | | |
| for rated accuracy | 20 °C to 25 °C | 10 to 90 % non condensing |
| without specifications | 20 °C to 30 °C | 10 to 90 % non condensing |
| Operating without charging | | |
| for rated accuracy | 20 °C to 25 °C | 10 to 90 % non condensing |
| without specifications | 10 °C to 40 °C | 10 to 90 % non condensing |
| Charging | 0 °C to 35 °C | 10 to 90 % non condensing |
| Storage | 0 °C to 35 °C | 5 to 95 % non condensing |

13.12 Certifications and Compliances

| | |
|-------------------------------------|-----|
| CE mark compliance | Yes |
| RoHS | Yes |
| REACH | Yes |
| EN 55011:2016/A1:2017 | Yes |
| EN 55022:2011/C1:2011 | Yes |
| IEC 61000-6-1:2019 EN | Yes |
| IEC 61000-6-3:2007/A1:2011/C11:2012 | Yes |
| ICES-001:2004 | Yes |
| AS/NZS CISPR 11:2011 | Yes |
| IEC 61010-1:2010/A1:2019 | Yes |
| UL 61010-1, Edition 3 | Yes |

13.13 Measure leads

| | |
|-------------------------------|--|
| Model | TP-C812B |
| Type | Differential |
| Connectors | |
| Instrument side | Isolated male BNC connector |
| Test point side | Red and black 4 mm shrouded banana plugs |
| Bandwidth | 7 MHz |
| Safety | CAT III, 1000 V, double isolated |
| Dimensions | |
| Total length | 2000 mm |
| Length to split | 800 mm |
| Length individual ends | 1200 mm |
| Weight | 80 g |
| Color | Black |
| Heat resistant | Yes |
| Certification and compliances | |
| CE conformity | Yes |
| RoHS | Yes |
| Accessories | |
| Color coding rings | 5 x 3 rings, various colors |
| Suitable instrument | WiFiScope WS6 DIFF |

13.14 Differential attenuators

| | |
|-----------------------|------------------------|
| Model | TP-DA10 |
| Attenuation | 10 x, differential |
| Bandwidth | 25 MHz |
| Input impedance | 10 M Ω // 15 pF |
| Maximum input voltage | 300 V |
| Input connector | Female BNC |
| Output connector | Male BNC |
| Dimensions | |
| Length | 79 mm |
| Diameter | 19 mm |
| Weight | 30 g |
| Suitable instrument | WiFiScope WS6 DIFF |

13.15 Package contents

| | |
|--------------------------|--|
| Instrument | WiFiScope WS6 DIFF |
| Measure leads | 4 x Measure lead TP-C812B, Differential BNC to 4 mm banana plug, 2 m long |
| Differential attenuator | 4 x Differential Attenuator TP-DA10 |
| Alligator clips, large | 8 x Alligator Clip TP-AC80: green, blue, yellow, red and 4 x black |
| Alligator clips, medium | 8 x Alligator Clip TP-AC10: green, blue, yellow, red and 4 x black |
| Alligator clips, small | 8 x Alligator Clip TP-AC5: green, blue, yellow, red and 4 x black |
| Accessories | Ground compensation cable TP-GCC150 with 3 alligator clips External power adapter network cable USB cable |
| Software | Windows 10 / 11, 64 bits, via website |
| Drivers | Windows 10 / 11, 64 bits, via website |
| Software Development Kit | Windows 10 / 11 (64 bits) and Linux, via website |
| Manual | Quick Start Guide, Instrument manual and software manual |

13.16 Warranty

TiePie engineering instruments are designed, manufactured and tested to provide high reliability. In the unlikely event you experience difficulties, the TiePie engineering instruments are fully warranted for two years.

| | |
|------------------------|---|
| This warranty includes | All parts and labor (excluding probes and/or measure leads and/or batteries) Warranty on batteries is 6 months. No charge for return shipping Long-term 7 year support Upgrade to the latest software at no charge |
| Optionally available | Extension to five year warranty, option W5 |

If you have any suggestions and/or remarks regarding this manual, please contact:

TiePie engineering
Koperslagersstraat 37
8601 WL SNEEK
The Netherlands

Tel.: +31 515 415 416
Fax: +31 515 418 819
E-mail: support@tiepie.nl
Site: www.tiepie.com



